

User Manual

Spotlight Camera



Model: S41/SPC

Table of Contents

Security Warning.....	1
1 Overview.....	2
1.1 Key Features.....	2
1.2 Read before Use.....	2
1.3 Packing Contents.....	3
1.4 Physical Description.....	3
1.5 SD Card Management.....	4
1.6 Add Device: Connection via the Foscam App.....	5
1.7 Installation.....	8
2 Access the IP Camera in Foscam App.....	10
2.1 Foscam APP Surveillance Window.....	10
2.2 Watch Live.....	11
2.3 Camera Setting.....	16
3 Surveillance Software Foscam VMS.....	26
3.1 Hardware Connection & Software Installation.....	26
3.2 Create Account.....	26
3.3 Add Device.....	27
3.4 Surveillance Software GUI.....	35
3.5 Advanced Camera Settings.....	39
4 Appendix.....	71
4.1 Frequently Asked Questions.....	71
4.2 Default Parameters.....	75
4.3 Specification.....	75
4.4 CE & FCC.....	76
4.5 WARRANTY.....	77
4.6 Statement.....	79
5 Obtaining Technical Support.....	81

Security Warning

- Please change the password of your spotcam regularly, using a combination of numbers, letters and special characters.
- We recommend that you regularly update your spotcam to the latest available software and firmware versions to help ensure the best experience for your Spotlight Camera.

1 Overview

Welcome to use our product, Spotlight Camera. Foscam Spotlight Camera is an integrated IP Camera with a color CMOS sensor enabling viewing in High Definition resolution. It combines a high quality digital video camera, with a powerful free Foscam Video Management Software, to bring clear video to your desktop from anywhere on your network or over the APP.

It supports P2P function. Thanks to the P2P easy access technology, you don't need to do complicated Port Forwarding and DDNS settings, you just need to scan the QR code on the side of the camera to connect it on smart phone, or input the UID on CMS software to realize remote access.

The Spotlight Camera supports the industry-standard H.264+ compression technology, drastically reducing file sizes and conserving valuable network bandwidth.

The Spotlight Camera adds the bright motion-triggered LED spotlight to the IP cameras, which allows for color night vision and powerful deterrent effect for criminals. Loading with smart features like PIR and motion detection and siren, this outdoor spotlight cam gives you one-of-a-kind protection.

1.1 Key Features

- ◆ 4Megapixels Resolution
- ◆ Supports WPA and WPA2 Encryption
- ◆ Support full duplex real-time 2-way Audio
- ◆ Supports Human detection&PIR detection
- ◆ Supports maximum 110dB alarm siren
- ◆ P2P Feature for Easy Remote Access
- ◆ Support 2.4GHz&5GHz dual-band WiFi
- ◆ Supports image snapshot
- ◆ Supports dual-stream
- ◆ Built-in 2pcs white LED and 2pcs IR LED, has excellent night vision image
- ◆ Supports remote viewing & record from anywhere anytime
- ◆ Multi-level users management with password protection
- ◆ Supports multiple network protocols: IP、TCP、UDP、FTP、DHCP、RTSP、
- ◆ Providing Video Management Software to manage or monitor multi-cameras
- ◆ Supports sound detection
- ◆ Supports Alexa
- ◆ Supports Google Assistant
- ◆ Supports 128G Micro SD Card Storage(External) and Cloud storage

1.2 Read before Use

Please first verify that all contents received are complete according to the Package Contents listed below.

Before the Network Camera is installed, please carefully read and follow the instructions in the Quick Setup Guide to avoid damage due to faulty assembly and installation. This also ensures the product is used properly as intended.

1.3 Packing Contents

• Camera× 1	• Ethernet Cable× 1
• Ethernet port waterproof kit × 1	• Expansion Screws× 1
• Quick Setup Guide × 1	• Mounting bracket× 1
• Power Adapter × 1	

1.4 Physical Description

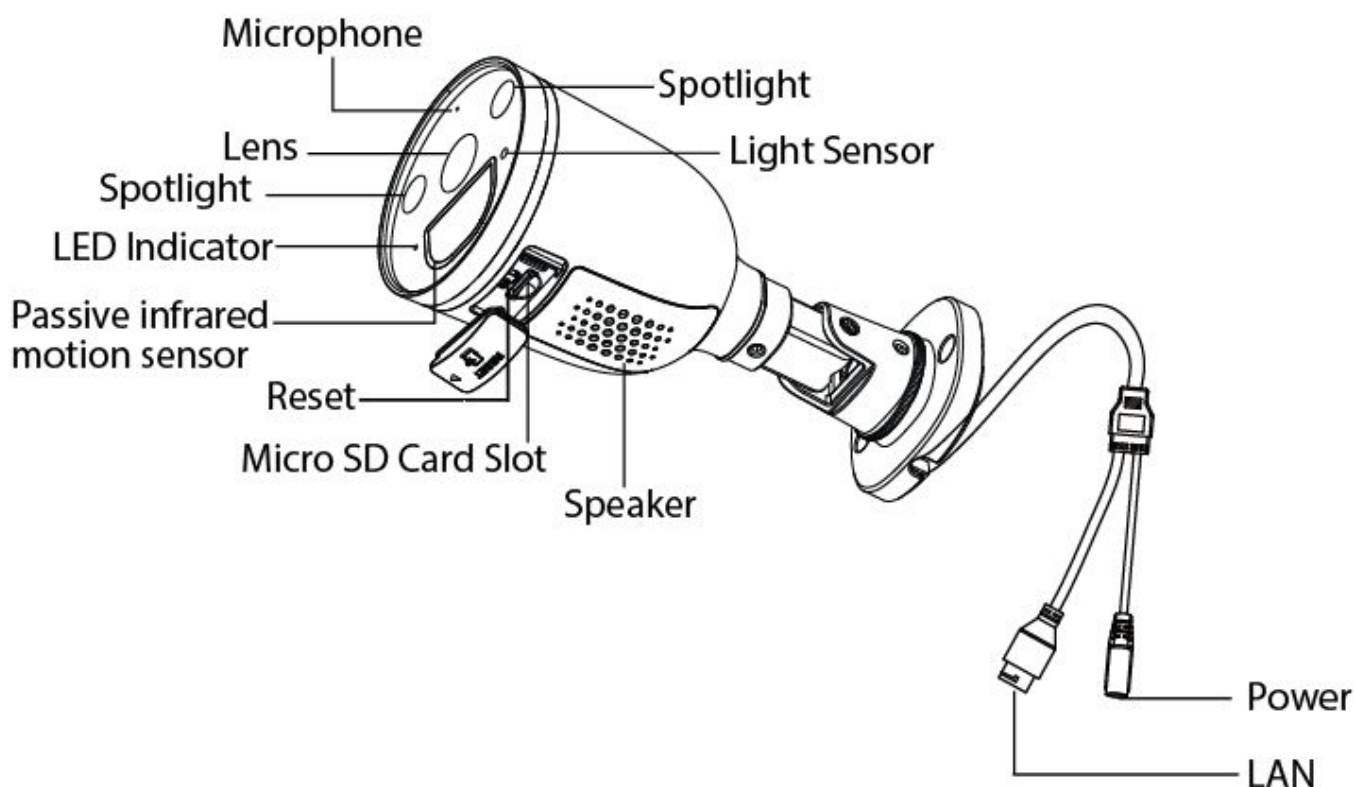

Microphone: Built-in Microphone.

Lens: Fixed focus lens.

Spotlight: See full-color images at night with the spotlight on.

LED Indicator: Infrared LED for night vision.

Passive Infrared motion sensor: The Passive Infrared motion sensor is electronic devices which are used in some security alarm systems to detect motion of an infrared emitting source, usually a human body.

Reset: Press and hold on the reset button for 10 seconds. Releasing the reset button, the password will back to the factory default administrator password.

Micro SD Card slot: Supports up to 128GB SD card for storing the video.

Speaker: Built-in speaker

Power: AC wiring interface.

LAN:10/100M adaptive Ethernet interface. Through this interface, IP camera can be connected with various network devices, such as hub, router, etc.

NOTE: There are up to two labels located at the bottom of the camera, this is an important feature of original Foscam cameras. If your camera does not have labels, it may be a clone. Cloned Foscam cameras can not use original firmware and are not eligible for warranty or technical services.

1.5 SD Card Management

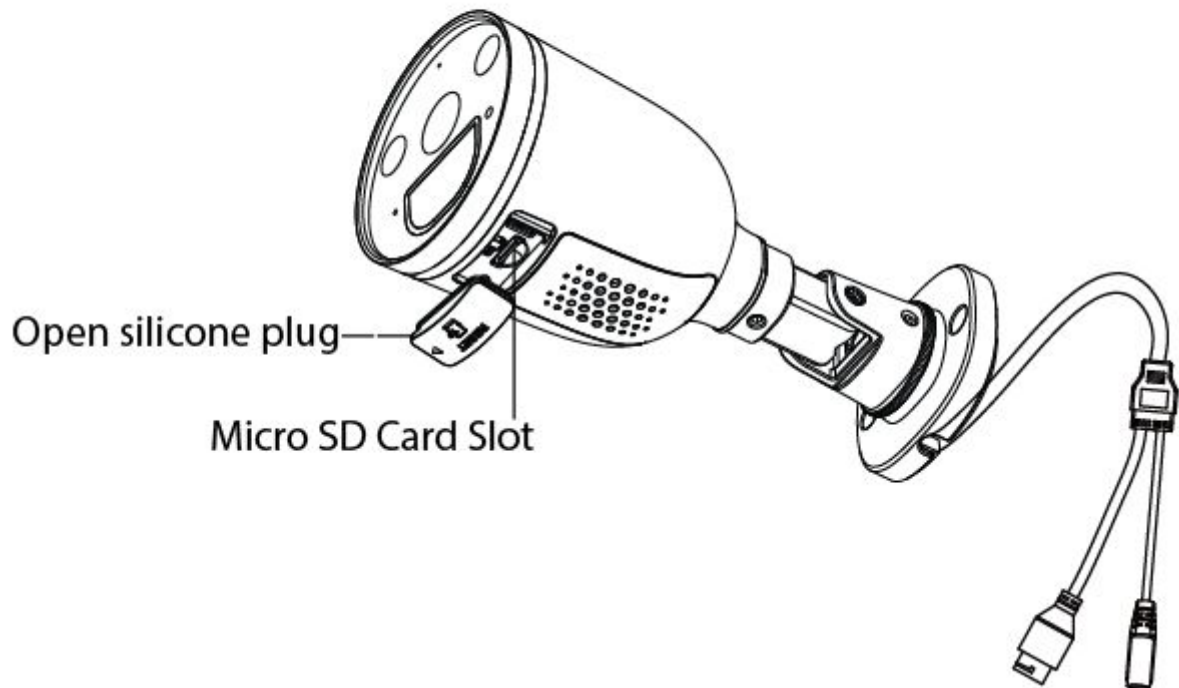

The record files of the IP camera can be stored in the Micro SD Card.

This camera supports Micro SD Card and the max size of Micro SD card must be under 128G.

You need open the silicone plug, then plug the Micro SD card into Micro SD card slot inside the IP camera.

When you plug in the Micro SD card during the camera work process, please reboot the camera again, or else the Micro SD Card may be cannot work well. When you re-install the cover, please ensure the tightness with the camera.

Warning: After installing the Micro SD card, please cover the silicone plug in time to prevent water or steam from falling into the device, causing damage or lens fog.

1.6 Add Device: Connection via the Foscam App

Scan the QR code below to download and install the Foscam APP.



To ensure a smoother video experience on your smart phone, it is recommended that your smart phone meet the following specifications:

iOS: version 11 or higher.

Android: 4.1 or higher, using a device with a Graphics Processing Unit (GPU).

Note: For the best experience, please update the APP to the latest version!

1.6.1 Wired Connection via the Foscam App

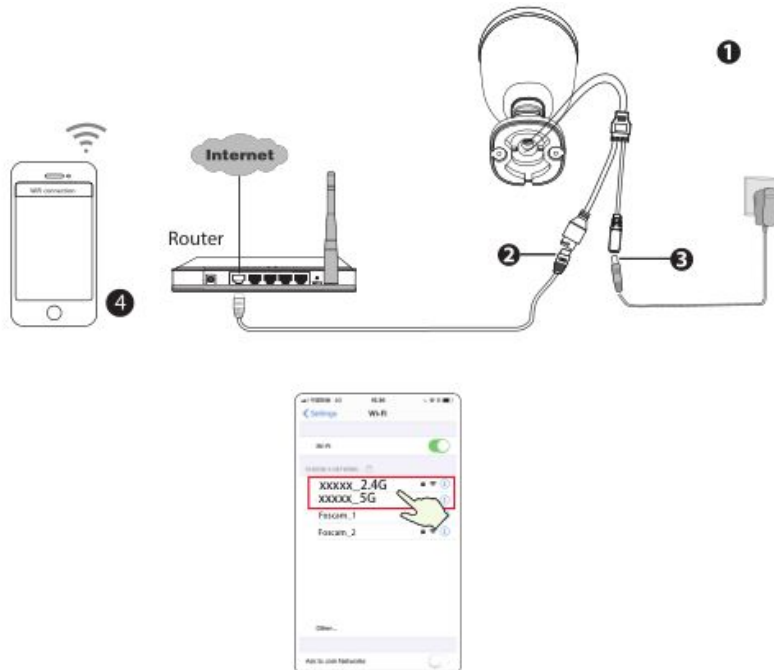

Please refer to the **Quick Setup Guide**.

1.6.2 WiFi Connection via the Foscam App

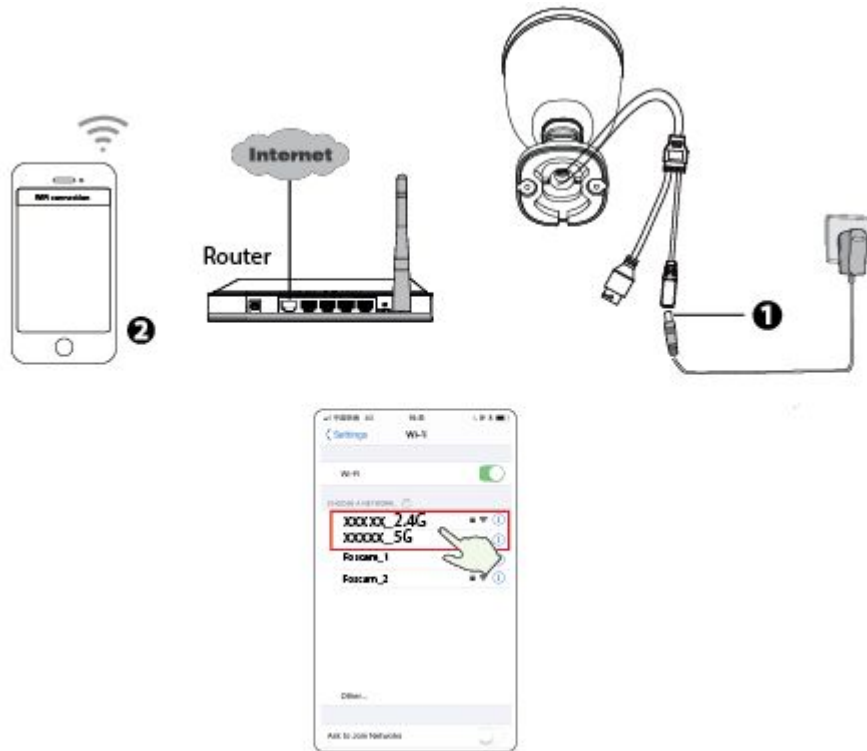

1. Plug the power adapter into the camera, and please wait for a few seconds until hearing the “**Ready for WiFi configuration**”.

Tips: If you didn’ t hear the voice prompt, press and hold reset for about 10 seconds to reset the camera.

2. Make sure that your smart phone is connected to your WiFi router.



3. Open the foscama APP and please sign up for a Foscam account, or sign in if you have one already.

4. After logging into Foscam APP, select “Tap to add a camera” or “+” icon on the upper right corner, then select “Scan the QR code” and scan the QR code that labeled at the bottom of your camera.

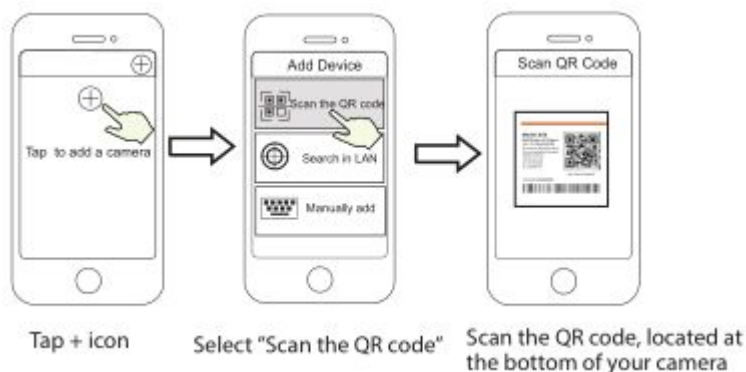

5. . In “Add Device”, if you hear "Hello Foscam", select the checkbox and tap "Next", continue to confirm that the device is in the blue flashing state and tap "Next". In “WiFi connection”, enter your WiFi's password and tap "Confirm".

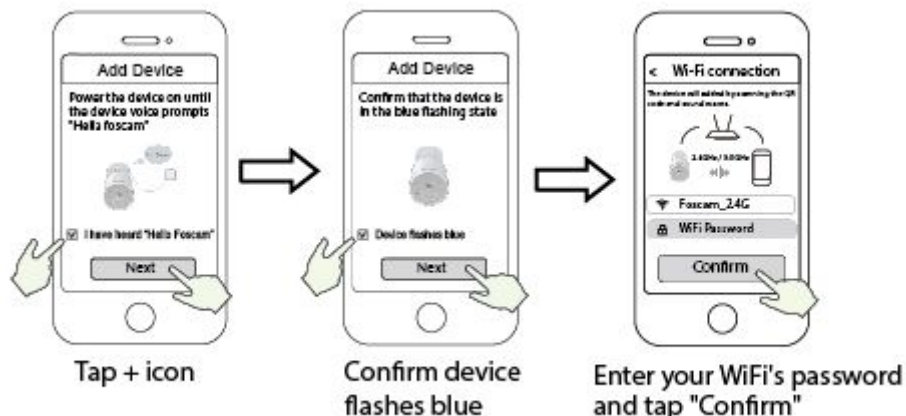

6. Please scan the QR code on the spotcam with the smartphone camera, then you will hear a voice prompt say " WiFi connecting" . Select the checkbox and tap " Next" .

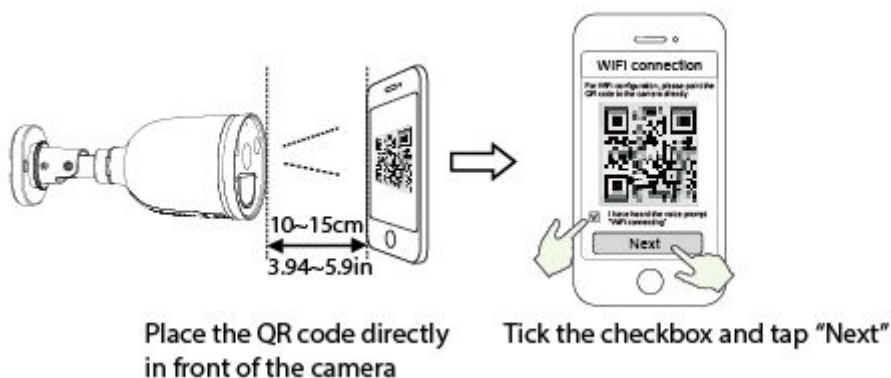

Tips: Please place the QR code on the phone screen about 10 to 15cm (3.94 to 5.9in) away, and if you encounter difficulties you can try to move the screen slowly around 10 - 15cm (3.94 - 5.9in).

7. Wait a few seconds until the camera notifies you that the “Wireless connection succeeded” , which means your camera has connected to your WiFi successfully. After, you can set the camera name and tap “Save” in "Set name" interface.



Camera added successfully and the name has been set

Note: If the process of adding a camera fails, please reset your camera and try adding again according to the above method.

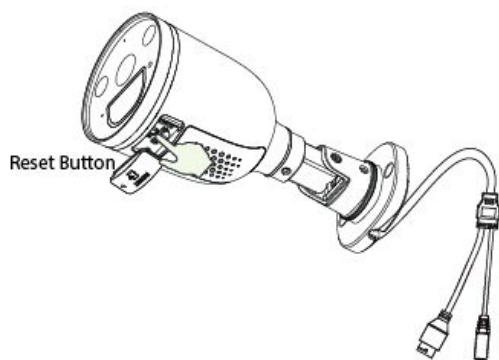

8. Tapping on the play button within the video box will jump to the “Camera Login” setting interface. For your security, please set a new username and password for your camera before viewing live video.

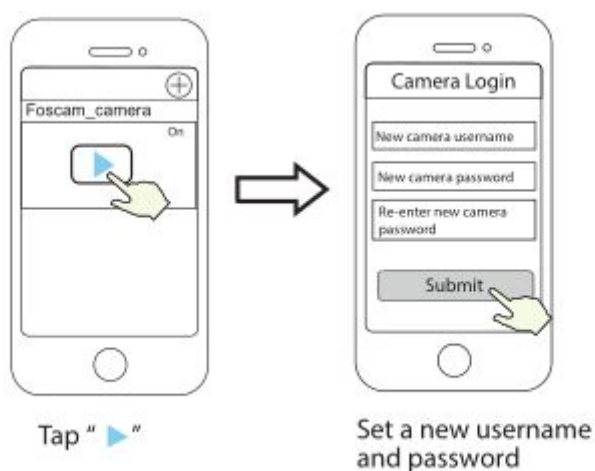

9. After completing the above steps, you can begin to use the camera.

1.7 Installation

Please refer to the **Quick Setup Guide**.

Point the camera at the desired location and use the screws provided to mount it.

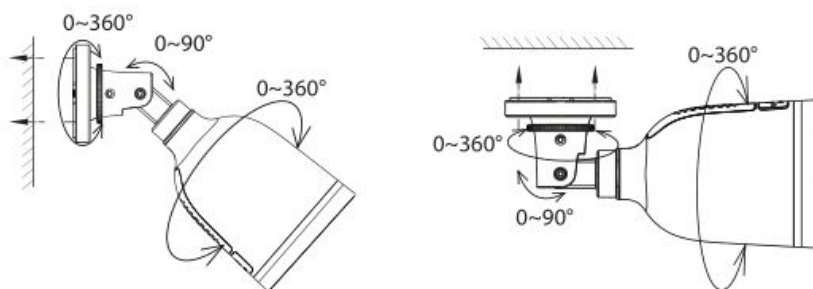

For the best product experience, we suggested installation height of Spotlight camera: 2.2m (7.22 feet), camera downward tilt angle 30° .

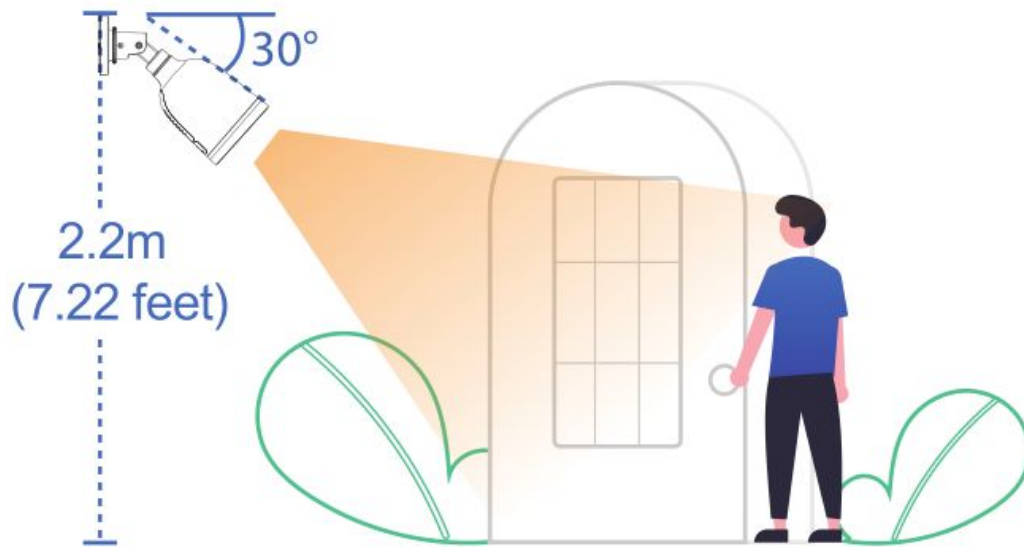

Please Note:

Ensure that rain or water will not reach the connector ports at the end of the pig tail wiring. These connectors are not weather-resistant.

2 Access the IP Camera in Foscam App

After setting up your spotcam in the app, select it this will bring you to the Device Dashboard, where you can change settings and access various features.

2.1 Foscam APP Surveillance Window

Please refer to the [section 1.6](#) if you install the camera for the first time. You can start to learn about software operation after finish quick installation. When you launch the Foscam App, the devices page displays.

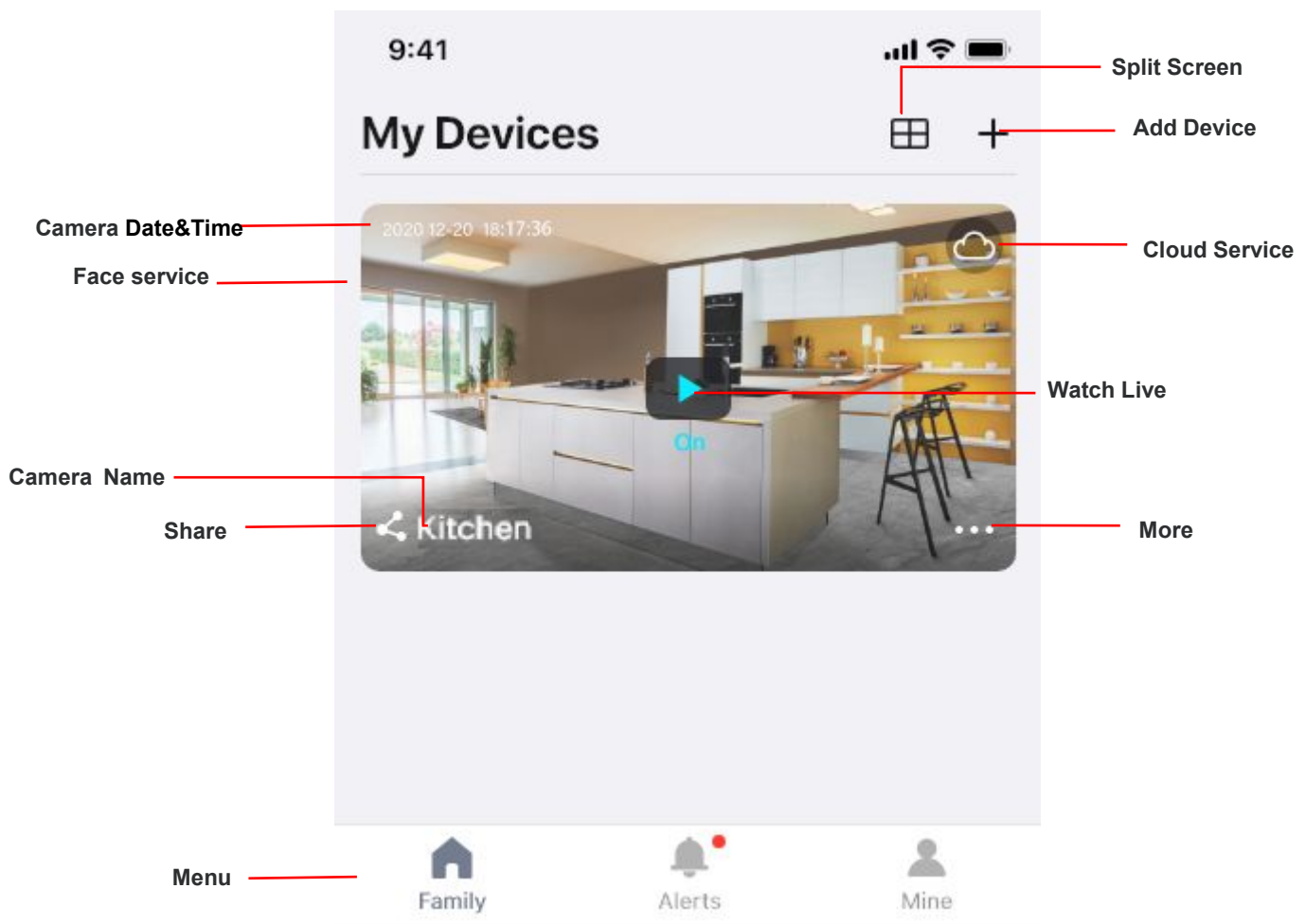





Camera Name: A camera name which is displayed in the Foscam Cloud Service.

You can rename your camera's name by tap Live  > Camera Settings  > Camera Info .

OSD: Including camera name and camera time, camera name can not be renamed but camera time can be in synchronized with the phone.

Sync Time: Tap Live  > Camera Settings  > Sync Time .

Camera Date&Time: You can Sync Time, tap Live  > Camera Settings  > Advanced Settings > Sync Time.

Share: You can share the camera with your family or other users to watch, tap Live  > Camera Settings  > Share Camera > Family or Invite.

Cloud Service: Foscam Cloud can save every alarm detection videos in ht cloud, and you can review every event anywhere, any time.

More: Click  the button to enter the more options page of the camera, Album, Alarm Settings, Playback, Notification, Settings, Siren and Spotlight.

Add Device: Please refer to the **Quick Setup Guide**.

Split Screen: Click  button, you can watch the live interface of 4 devices.



2. 2 Watch Live

Tap Live  to view and listen to a live video

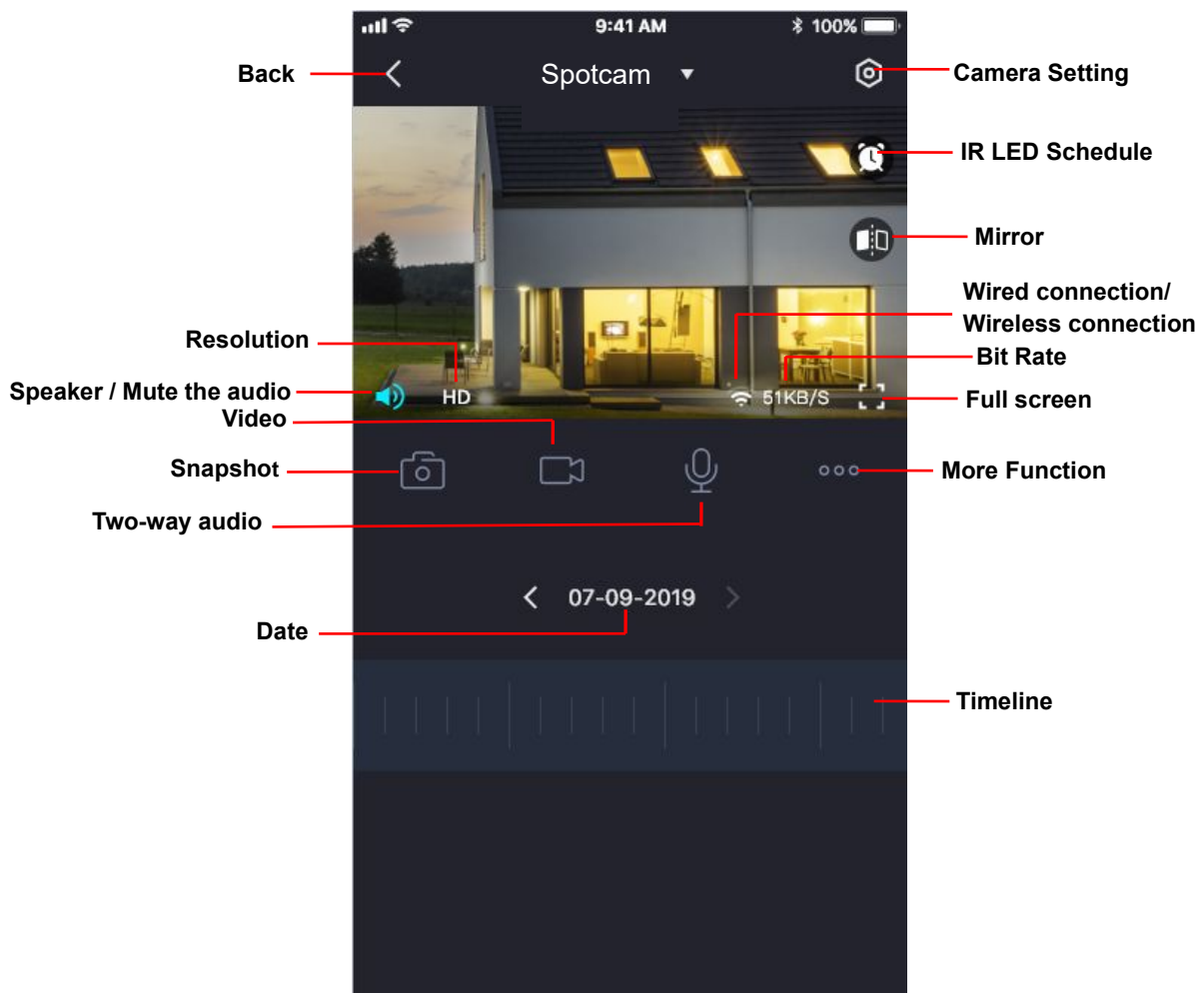

Back: To stop viewing and listening to the live feed, tap the **Back**.

Resolution: There are three types to identify different streams you have set. If select the QHD Mode, the clearer video will become, and it will take up more bandwidth; If select the HD Mode, the video will not be as clear as QHD Mode, and it will take up less bandwidth. The FHD Model is a value between FHD Mode and SD Mode.

Resolution: Generally speaking, the larger the bit rate is, the clearer video will become. But the bit rate configuration should combine well with the network bandwidth. When the bandwidth is very narrow, and bit rate is large, that will lead to video can not play well.

On this screen, you can listen to a live stream, record clips, take a snapshot, activate two-way talk or full screen.

If you want to catch the smaller details, pinch and drag any image as you do with photos on your smart phone.

Speaker / Mute the audio: Here you can see if there is a Speaker or muted.

Video: Click this button to start the recording function.

Snapshot: Click this button to Snapshot the image.

Two-way audio: Press and hold this button to enable microphone intercom.

Date: Show date, Display the date, you can select the date through “<” or “>”button.

Timeline: If you have purchased cloud service, you can click the timeline to watch the storage video at the corresponding time on the cloud.

Camera Setting: Click this button to set more.

IR LED Schedule: On this page, you can enable/disable the IR LED, and set the IR auto switch or you can schedule it.

Auto: As default, the IR-Cut auto switch is ON, it means that the IR LED will be OFF during 9:00~18:00, and the IR LED will be ON at the other time.

Day: it means that the IR LED will be OFF all the time.

Night: it means that the IR LED will be ON all the time.

Schedule: You can schedule the time to turn the IR LED OFF/ON.

Mirror: You can flip the image horizontally with this button.

Wired connection / Wireless connection: You can use this to see whether the current camera is in a wired or wireless connection.

Bit Rate: You can see the current connection bit rate.

Full screen: Click this full screen button, you can live in full screen.

More Function: Here you can set Activity Detection and Sound Detection.

Note: Motion Detection and face Detection cannot be turned on at the same time.

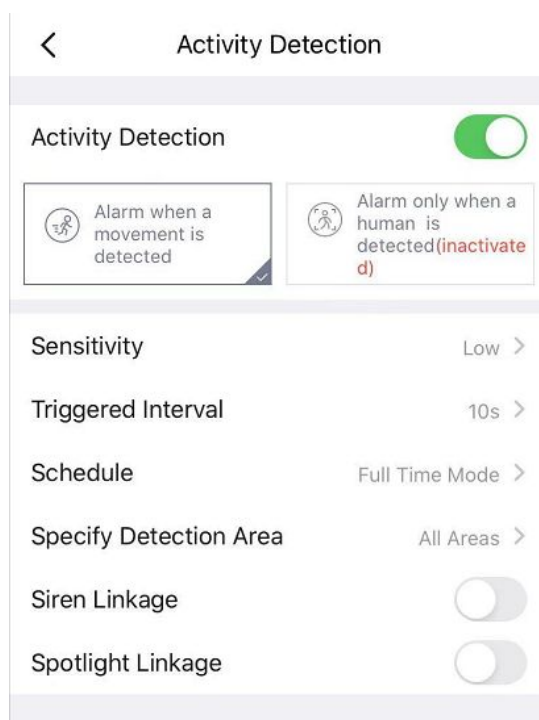

Activity Detection: To enable Activity detection, follow the steps below:

- 1 Enable Activity Detection button
- 2 Click Alarm when a movement is detected or Alarm only when a human is detected.
 Alarm when a movement is detected: Alarm when a movement activity is detected.
 Alarm only when a human is detected: Alarm only when a human is detected.
- 3 Sensitivity---- It supports three modes: Low, Middle and High. The higher the sensitivity, the camera will be more easily alarmed. Select one motion sensitivity.
- 4 Triggered Interval----The interval time between two motion detection. Here supports 5s/6s/7s/8s/9s/10s/11s/12s/13s/14s/15s. Select one interval time.
- 5 Schedule: Click the rectangle in the day of the week, and the corresponding time setting will be selected. For example, click "Sun", the time "00:00~24:00" will be set in "Sun", which means that when there is an object moving in the detection area, the APP will receive the camera's Motion alarm Push messages.

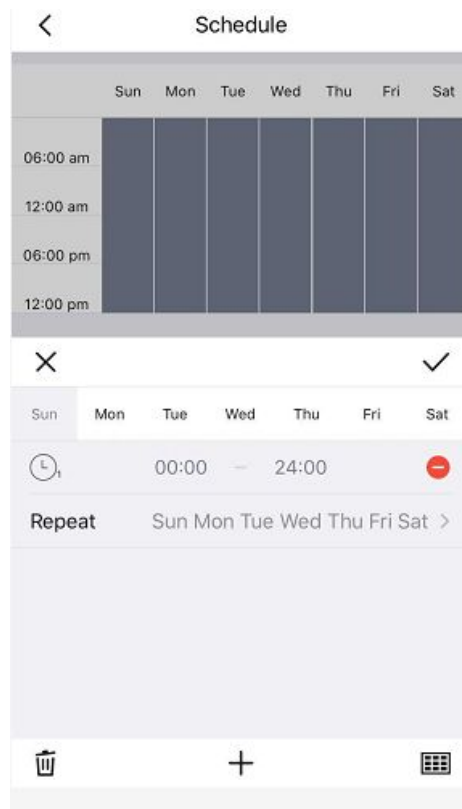

- 6 Specify Detection area: Drag the selection box to select the alarm area,click back to pop up Save or Cancel, select save.

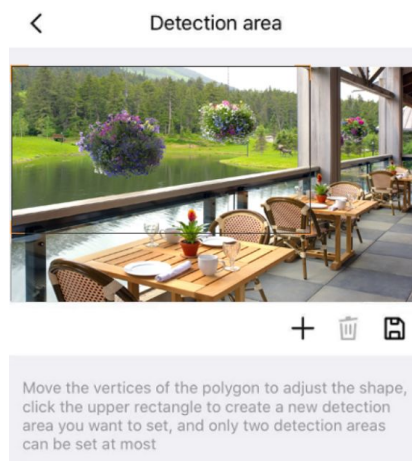

NOTE: You must set the detection area and detection schedule, or else there is no alarm anywhere and anytime.

Siren Linkage: When an alarm is triggered, the camera makes a sound. You can turn it on as needed.

Spotlight Linkage: When an alarm is triggered, and at night, the spotlight lights up, you can turn it on as needed.

Sound Detection: To enable Sound detection, follow the steps below:

- 1 Enable Sound Detection button
- 2 Sensitivity---- It supports three modes: Low, Middle and High. The higher the sensitivity, the camera will be more easily alarmed. Select a Sound sensitivity.
- 3 Schedule: Click the rectangle in the day of the week, and the corresponding time setting will be selected. For example, click "Sun", the time "00:00~24:00" will be set in "Sun", which means that when there is an object moving in the detection area, the APP will receive the camera's Face alarm Push messages.

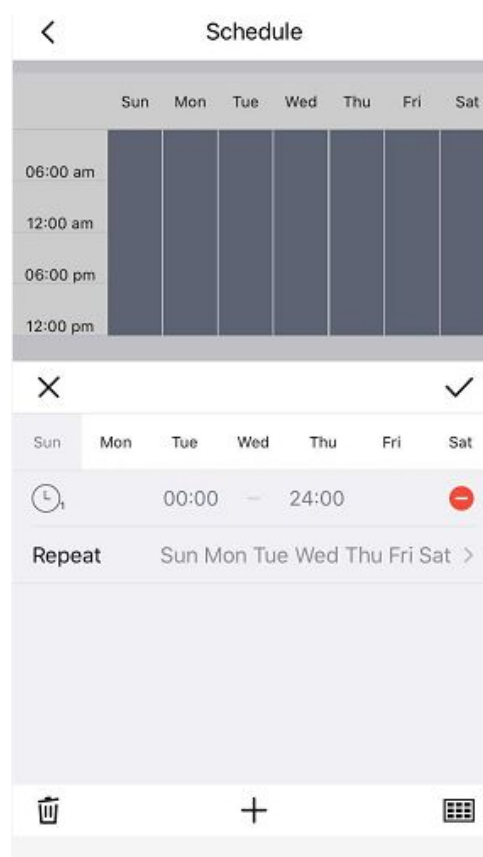

2.3 Camera Setting

Tap  the button, goes to Device Settings to make advanced camera settings.

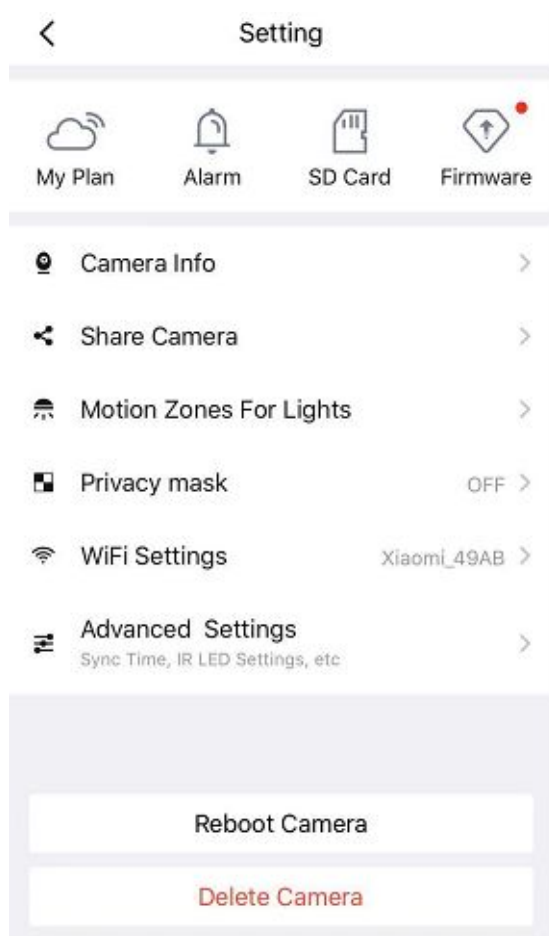

2.3.1 My Plan

Here you can choose a 7-day free cloud service experience, and you can also purchase related cloud packages according to your needs. After successful activation, you can enjoy storing videos on the cloud anytime, anywhere.

2.3.2 Alarm

Click this button, and then you can refer to More Function in **2.2**

< Alarm Settings

The camera triggers different types of alarms based on different scenes and pushes alarm notifications to the user. The device that purchased the cloud service will also upload alarm recordings to the cloud storage.

Motion Detection ON >

Sound Detection OFF >

2.3.3 SD Card

If you have an SD card on your device, click this button to enter the SD-Card Video Playback. You can filter the corresponding videos according to the time and type.

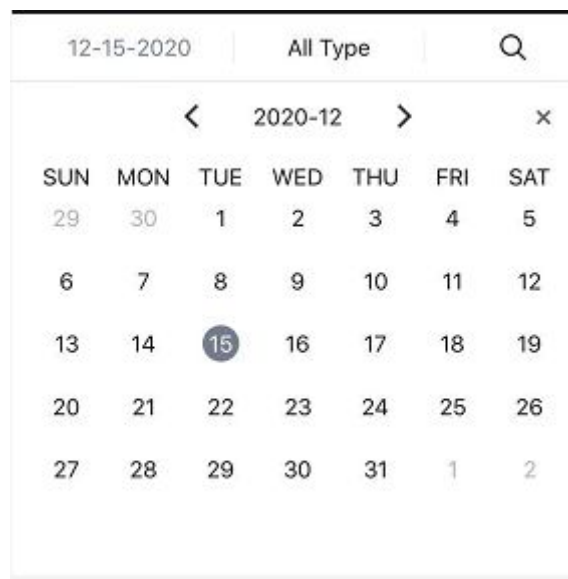

Settings

Click  the button enter to SD Card settings, you can set SD card info and Recording Schedule.

< SD card settings

SD card info >

Recording Schedule >

SD card info

Click the > button enter to SD Card settings, you can view the SD card storage information from this page, and you can also format the SD card.

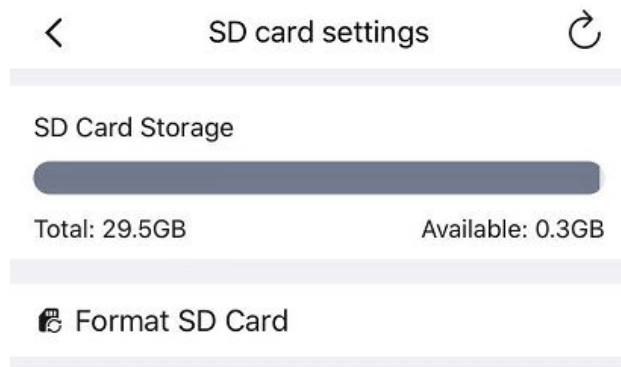

Recording Schedule

Click the > button enter to Recording Schedule setting, you can setting Loop Coverage, Voice Recording and Recording Schedule. Click Recording Schedule set and then click the rectangle in the day of the week, and the corresponding time setting will be selected. For example, click "Sun", the time "00:00~24:00" will be set in "Sun", which means that during this time period, the camera will automatically record to the SD card.

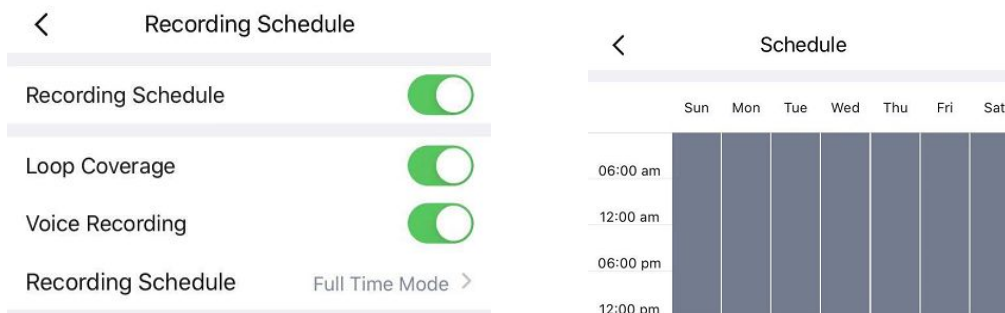

2.3.4 Firmware

You can see the current camera's firmware version and whether there is new software that needs to be upgraded. If there is new firmware, you can click the "Upgrade" button to upgrade.

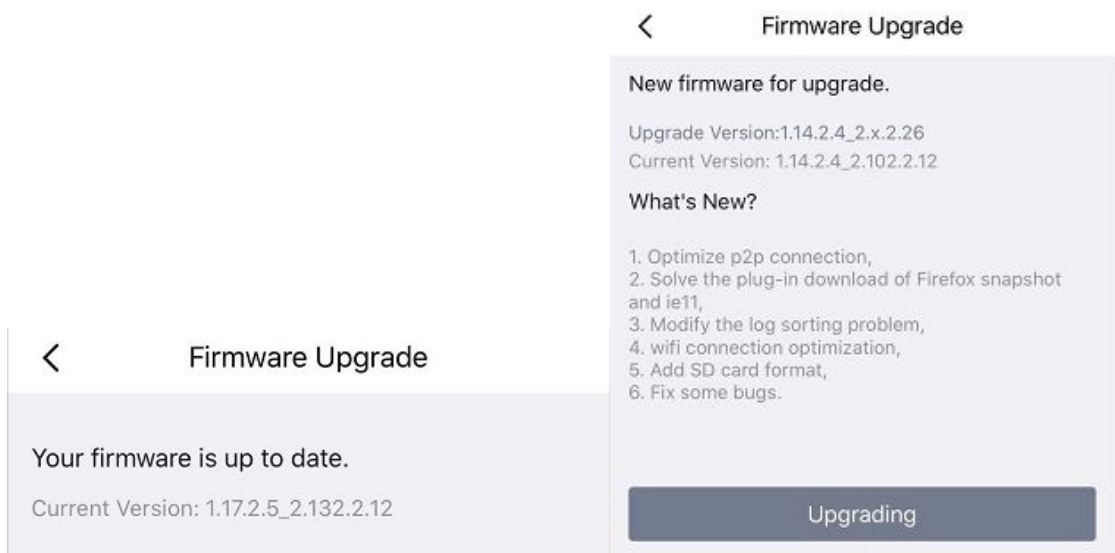

2.3.5 Camera Info

You can see the basic information of the camera through this, such as Camera name, UID, MAC ID and firmware version information.



2.3.6 Share Camera

If you set up family members in my family, you can share the camera with your family here. Or you can invite other users to watch the live broadcast in the form of username and account information.

< Invite

Invited Account

Nickname

Account

Share Time

3 Days 7 Days 30 Days

90 Days 180 Days Permanent

Sharing Permissions

Live Video

Share

2.3.7 Motion Zones For Light

Customize the area where you want motion to turn on your light.

< Motion Zones For Lights ?

Customize the area where you want motion to turn on your lights



SENSITIVITY

Min Max

Timer for lights 30s >

The time of keeping lights on after motion

2.3.8 Privacy mask

This can be used to set certain masks as private areas on the video. Click + draw a mask area on the video , the mask area will be black on the video .Click the back button, the save page appears, click save, click Save to take effect.

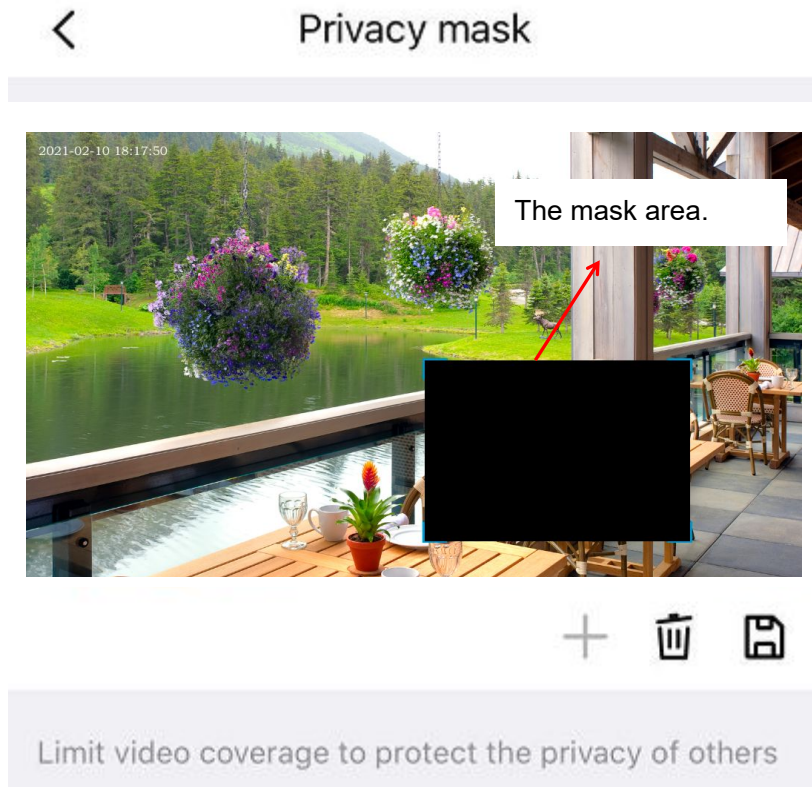

Back to the surveillance window, you can see the mask area as the following picture:

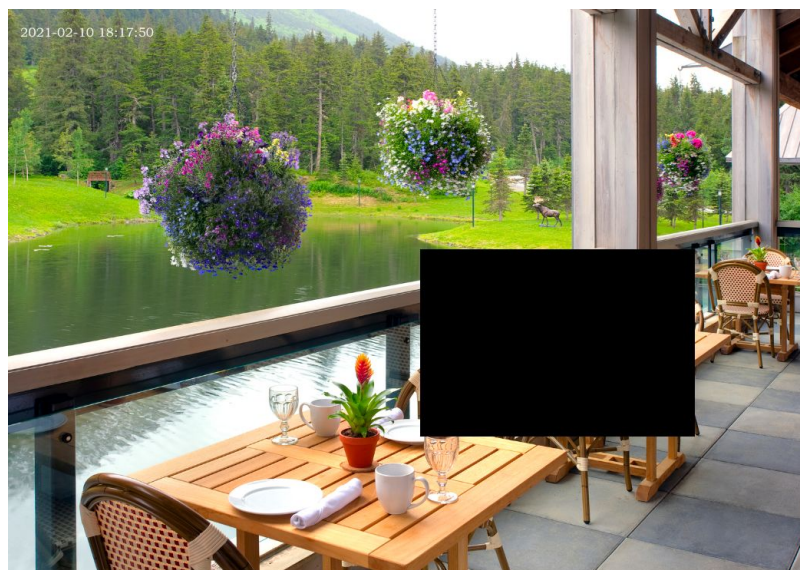

2.3.9 WiFi Settings

If you selected Wired Connection via the Foscam, Tap the “WiFi Settings” button > select your WiFi network and enter your WiFi’s password. After setting up successfully, you can view live video without the Ethernet cable.



2.3.10 Advanced Settings

Click on advanced settings to enter the advanced settings page, where you can set Security Settings, Light Settings, Power Frequency, Smart Control, Sync Time, NVR Connection, Restart Device, Reset Device, Video Settings, Prompt Settings, Screen Flip and Camera Speaker Volume settings.

Security Settings

You can modify the username and password of the camera here

Light Settings

On this page you can set the IR LED Settings and White Light.

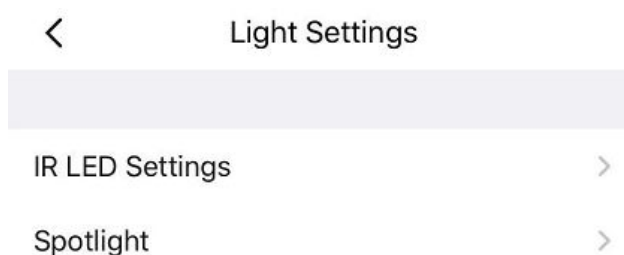

IR LED Settings: You can set according to your needs

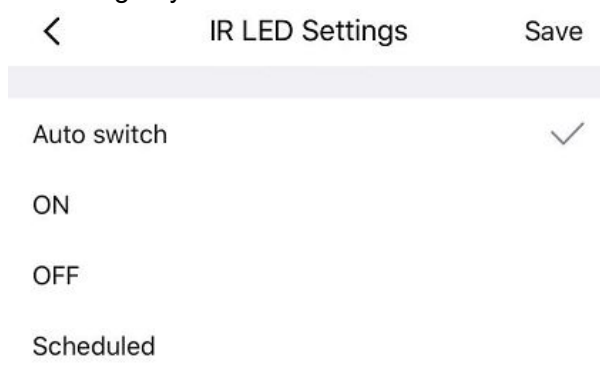

Spotlight: You can set according to your needs

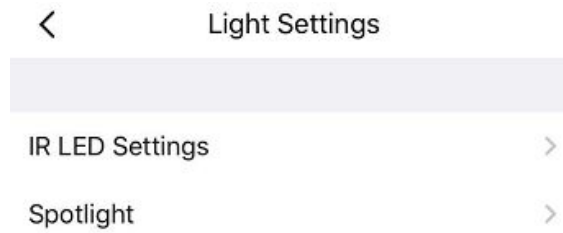

Power Frequency

You can see the power supply type from here.



Smart Control

On this page you can set Device Name and Region.

Note: Please select the corresponding to the area where your third-party smart speaker account is registered. If the connection is abnormal, you can try to change the area or contact Foscam customer service or contact third-party customer service to change the area registered by Alexa app.

Sync Time

On this page, you can set the camera time, which can be synchronized with the phone time or NTP auto Sync and you can also select the time zone.

NVR Connection

If your device has been added to one of FN7108HE / FN3109H / FN3104H, please be sure to turn on this switch, otherwise the recording will be unsuccessful, and your live broadcast screen will switch to 720p. If it is not added under NVR, please close it.

Restart Device

You can restart your camera from here.

Reset Device

You can reset your camera from here.

Video Settings

On this page you can set show time Overlay, Show Camera Name Overlay, Network Auto-Adaptability and HDR Settings.

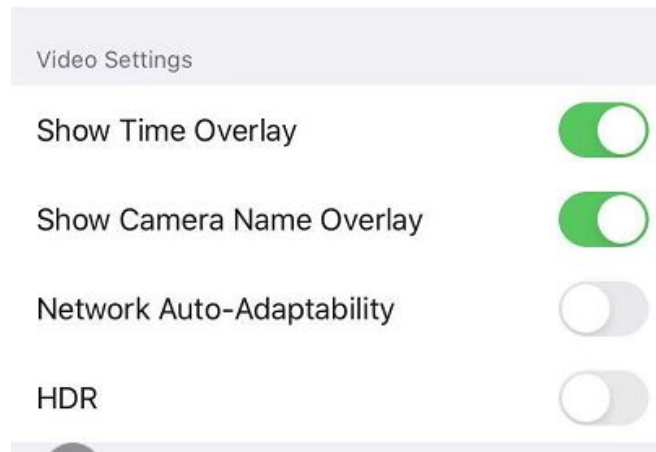

Prompt Settings

On this page you can set Status LED and Voice Prompt

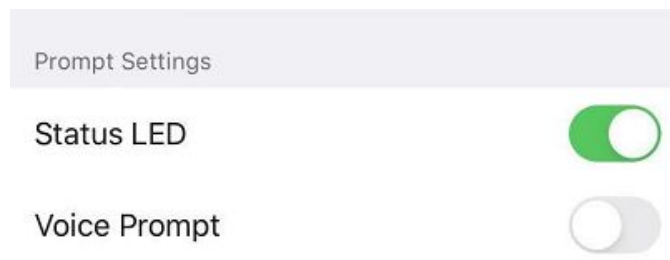

Screen Flip

On this page you can set Screen Flip.

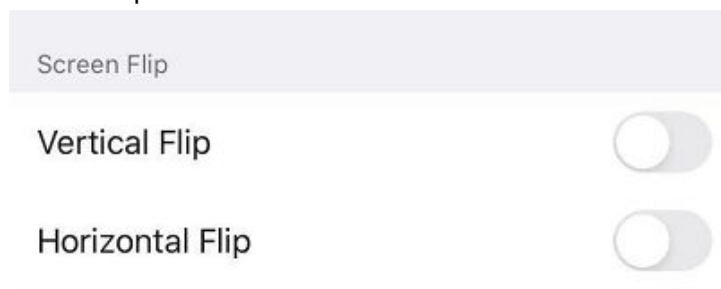

Camera Speaker Volume

On this page you can set Camera Speaker Volume, you can adjust the volume by dragging.



2.3.12 Reboot Camera

Click **Reboot** to reboot the camera. This is similar to unplugging the power to the camera.

2.3.13 Delete camera

You can click the delete Camera button to delete the camera from the app, or delete and keep history files from the app.

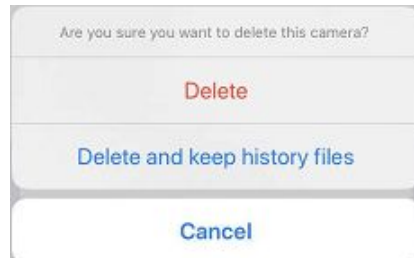

3 Surveillance Software Foscam VMS

3.1 Hardware Connection & Software Installation

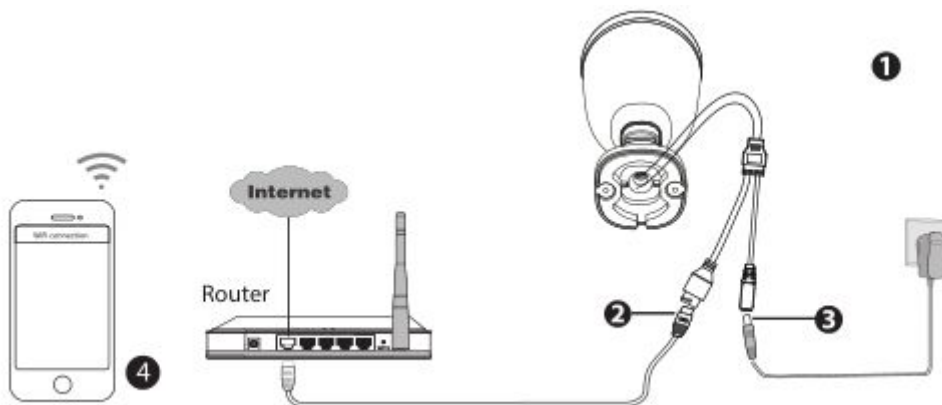

1. Connect the camera to the network, make sure it is on the same network as the computer
2. You can download the "Foscam VMS" Windows version from foscam.com/vms , and can download the "Foscam VMS" Mac version from the APP store:
<https://apps.apple.com/cn/app/foscamvms/id1521202507?mt=12>
Download and install according to the installation wizard.

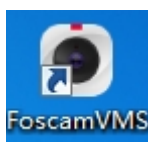

3.2 Create Account

You can create a local administrator account.

For security, it is strongly recommended to create local accounts and password management, which prevents the entry of intruders.

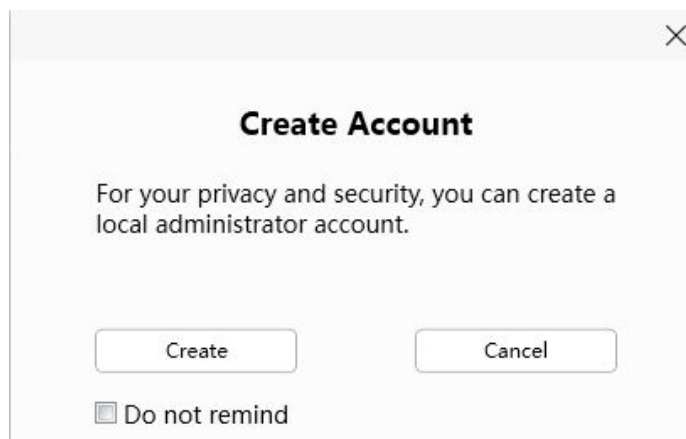

you haven't created a local administrator account, please click Create Account to create.

After creating a local administrator account, you can:

1. Use the account to log in to the client to ensure information security.
2. Create sub-accounts and assign different permissions for management.

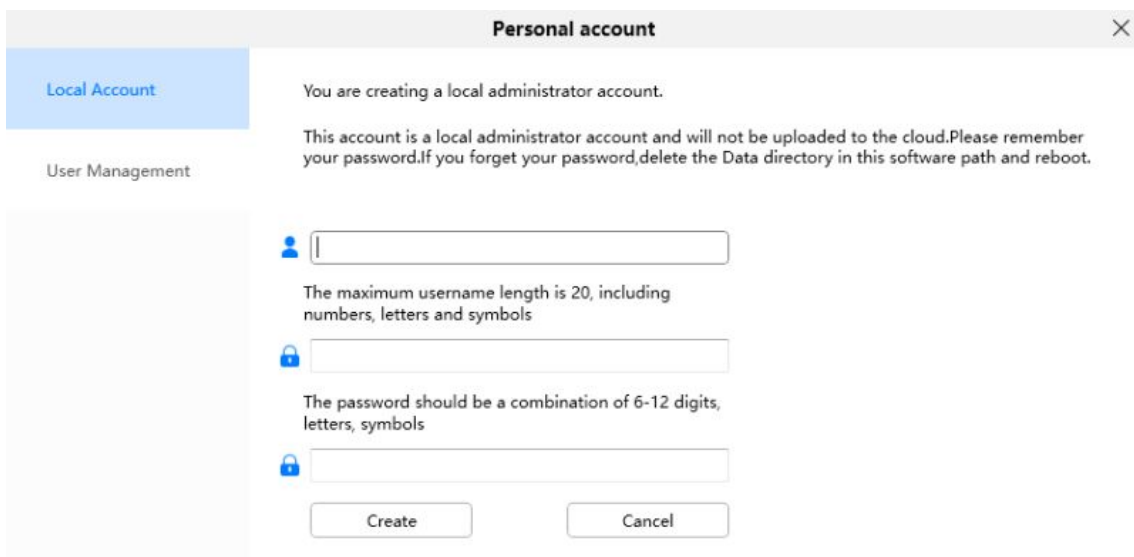

3.3 Add Device

3.3.1 LAN Add

If your spotcam is wired connect, you can choose the following method to add to FoscamVMS.

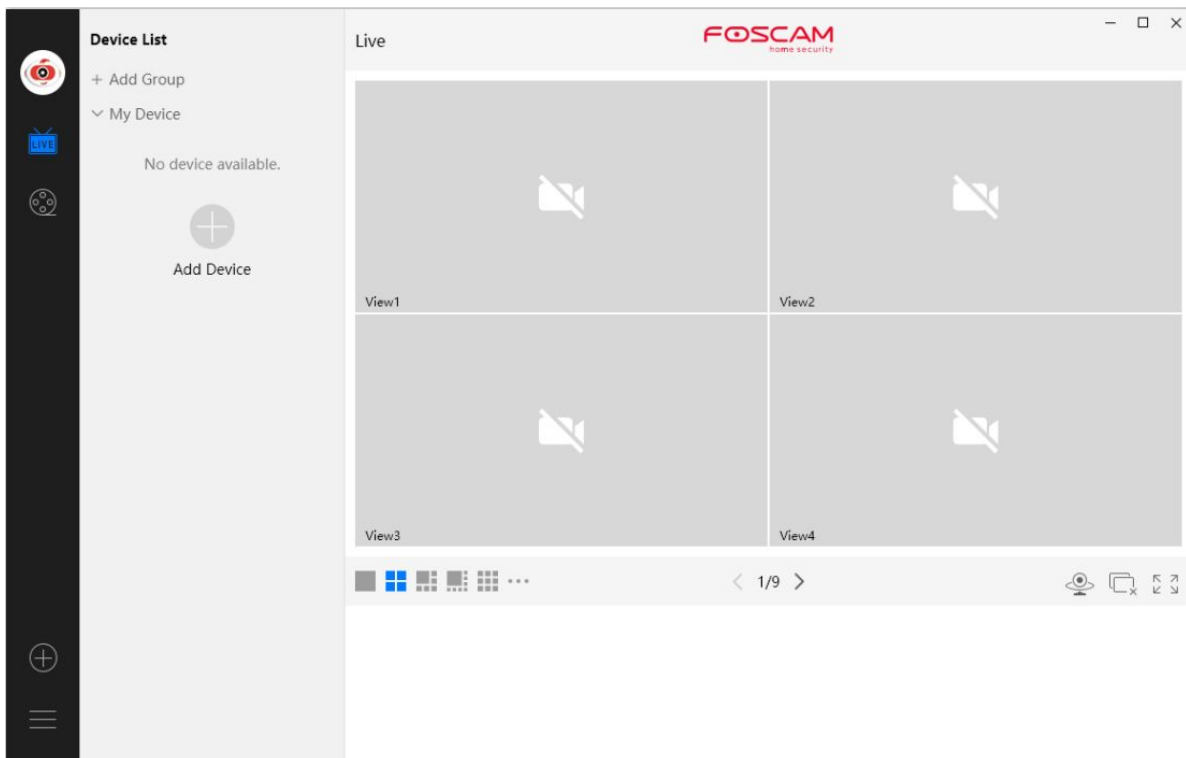

Click **Add Device**  button, then follow below steps:

Step1 Select “ALL” from the device types.

Step2 Click the IP address of the camera on the list, then the name of the camera and the IP information will be entered automatically.

Step 3 Click Add.

The 'Add Device' dialog box contains the following elements:

- Device type: All, IPC, NVR, Refresh button.

Name	Device type	IP	Port	MAC
Foscam_Camera	IPC	192.168.1.246	88	A0EE6F154E85

- + Connect the camera to WIFI button.
- 1 device(s) text.
- Buttons: Add (highlighted), Cancel, Manual add.

Step 4 Enter the username and password of the camera.

The 'Device account' dialog box contains the following elements:

- Text: Please enter the device account and password for your device.
- Device account :
- Password :
- Buttons: Add (highlighted), Cancel.

Please Note: Make sure the camera and PC are both in the same Local Area Network (LAN).

3.3.2 Manual add via IP

You can add the camera use manual add via IP also. Click the Manual add first, then follow below steps:

Add Device ✕

Device type : All IPC NVR [Refresh](#)

Name	Device type	IP	Port	MAC
Foscam_Camera	IPC	192.168.1.246	88	A0EE6F154E85

[+ Connect the camera to WIFI](#) ?

1 device(s)

- Step 1** Select the IP address from Connection Mode
- Step 2** Enter the IP and Port of the camera.
- Step 3** Select "IPC" or "NVR" from the Device types.
- Step 4** Click Add

Add Device ✕

Connection mode :

UID

DDNS Port :

IP address Port :

Device type :

IPC

NVR

- Step 6** Enter the username and password of the camera.

Device account ✕

Please enter the device account and password for your device.

Device account :

Password :

Add
Cancel

3.3.3 Manual add via UID

You can add the camera use manual add via UID also. Click the Manual add first, then follow below steps:

Add Device ✕

Device type : All IPC NVR ↻ Refresh

Name	Device type	IP	Port	MAC
Foscam_Camera	IPC	192.168.1.246	88	A0EE6F154E85

+ Connect the camera to WIFI ?

1 device(s)

Add
Cancel
Manual add

Step 1 Select the UID from Connection mode

Step 2 Enter the UID of the device.

Step 3 Click Add

Add Device [X]

Connection mode :

UID []

DDNS [] Port : []

IP address [] Port : []

[Add] [Cancel] [LAN add]

Step 4 Enter the username and password of the camera.

Device account [X]

Please enter the device account and password for your device.

Device account : [1]

Password : [*****]

[Add] [Cancel]

3.3.4 Connect the camera to WiFi

You can add the camera via Connect the camera to WiFi also. Click Connect the camera to Wi-Fi or the + button first, then follow below steps:

✕
Add Device

Device type : All IPC NVR ↻ Refresh

Name	Device type	IP	Port	MAC
Foscam_Camera	✓ IPC	192.168.1.246	88	A0EE6F154E85

+ Connect the camera to WiFi ?

1 device(s)

Step 1 Enter the **WiFi Name** and **WiFi Password**, then click **Next**
Note: Please reset your camera.

✕
Connect wireless camera to WiFi



Please reset your camera and input the WiFi informations

WiFi Name :

WiFi Password :

Step 2 Please scan the QR code above with the camera you want to add. After the scan is successful, click confirm.



Step 3 Return to the device list to connect the device, refer to the **LAN add steps**

3.3.5 Manually Add via DDNS

You can add the camera use manual add via DDNS also. Click the Manual add first, then follow below steps:

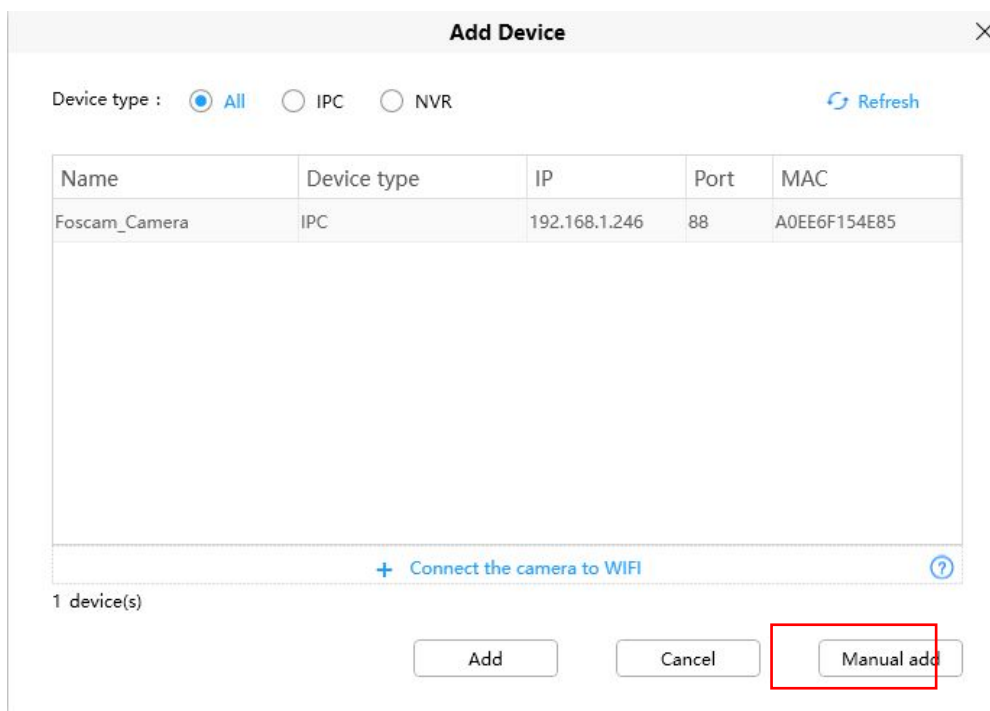

Step 1 Select the DDNS from the Connection Mode

Step 2 Enter the DDNS and Port of the camera.

Step 3 Select "IPC" or "NVR" from the Device types.

Step 4 Click Add

Add Device ×

Connection mode :

UID

DDNS Port :

IP address Port :

Device type :

IPC

NVR

Step 5 Enter the username and password of the camera.

Device account ×

Please enter the device account and password for your device.

Device account :

Password :

3.4 Surveillance Software GUI

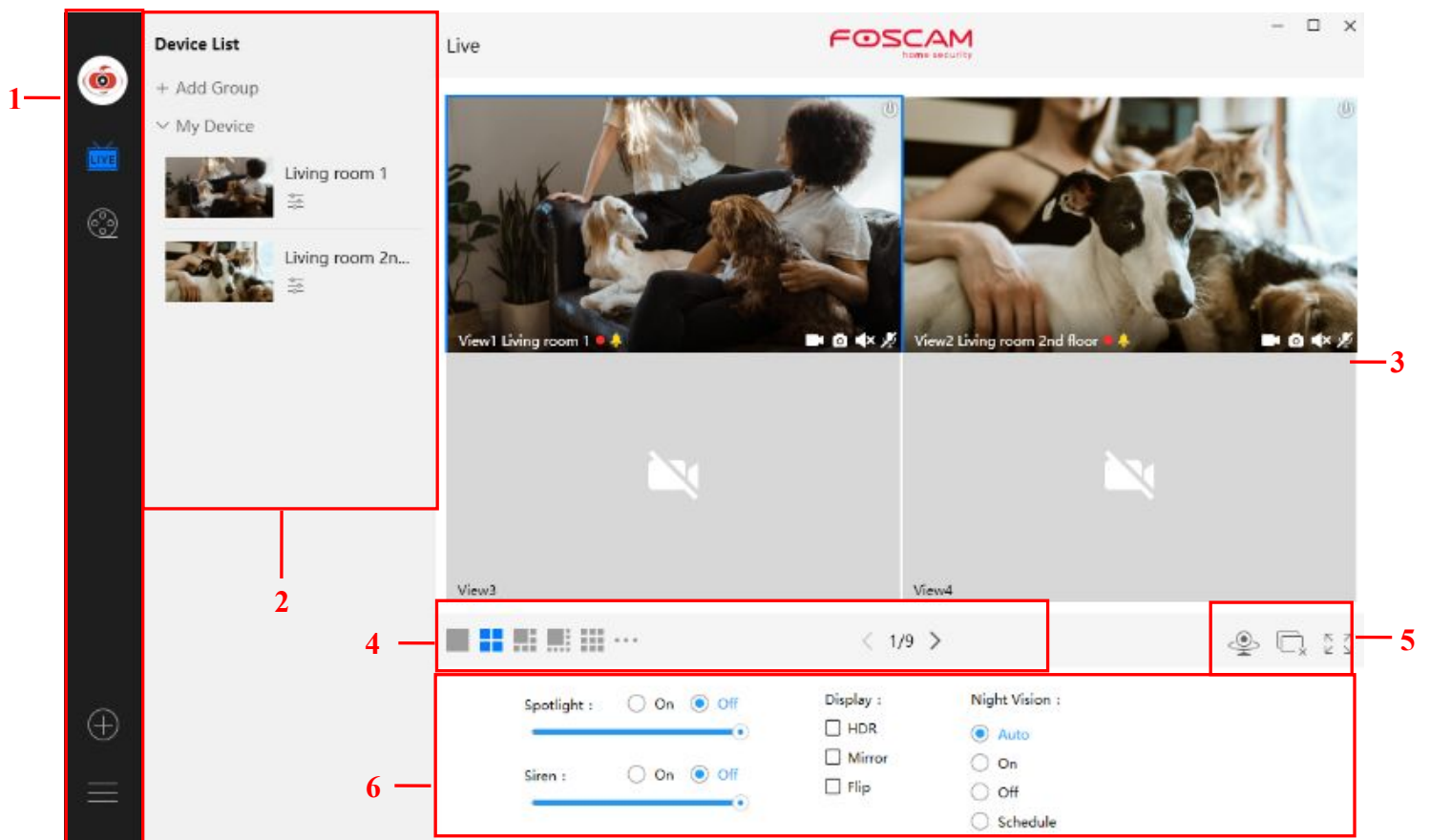

First time you login the software, the whole video window is gray, you need to connect the cameras and add cameras to it.

Section1 Menu Bar



Path to surveillance window. Click this button enter to Device List and back to the surveillance window.



Playback the video recording, you can choose playback type and play video on local or SD card.



Add Device, please refer chapter 3.4 for the detail setting.



More, You can Setting Personal Account, Preference, Left Bar and Switch Account.

Section2 Left Bar

Add Group: Click the **+ Add Group** button, you can group the device list according to your needs.

Left Bar of Live: You can view the list of connected cameras

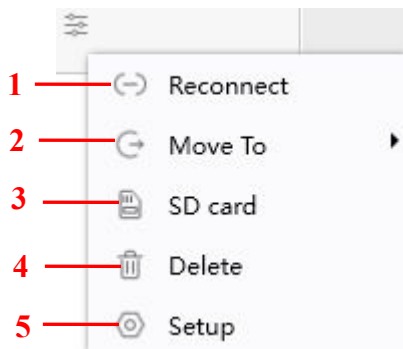

1-----Reconnect

Click the settings button and the device will reconnect.

2----- Move To

Click this button, you can move the device to your group list.

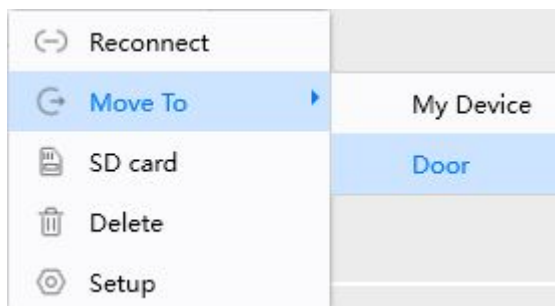

3-----SD Card

If you have an SD card on your device, click this button to enter the SD directory.

4-----Delete

Click the button, Delete the device.

5----- Setup

Click the button Settings, goes to **Device Settings** Control Panel to make advanced camera settings.

Section3 Live Window

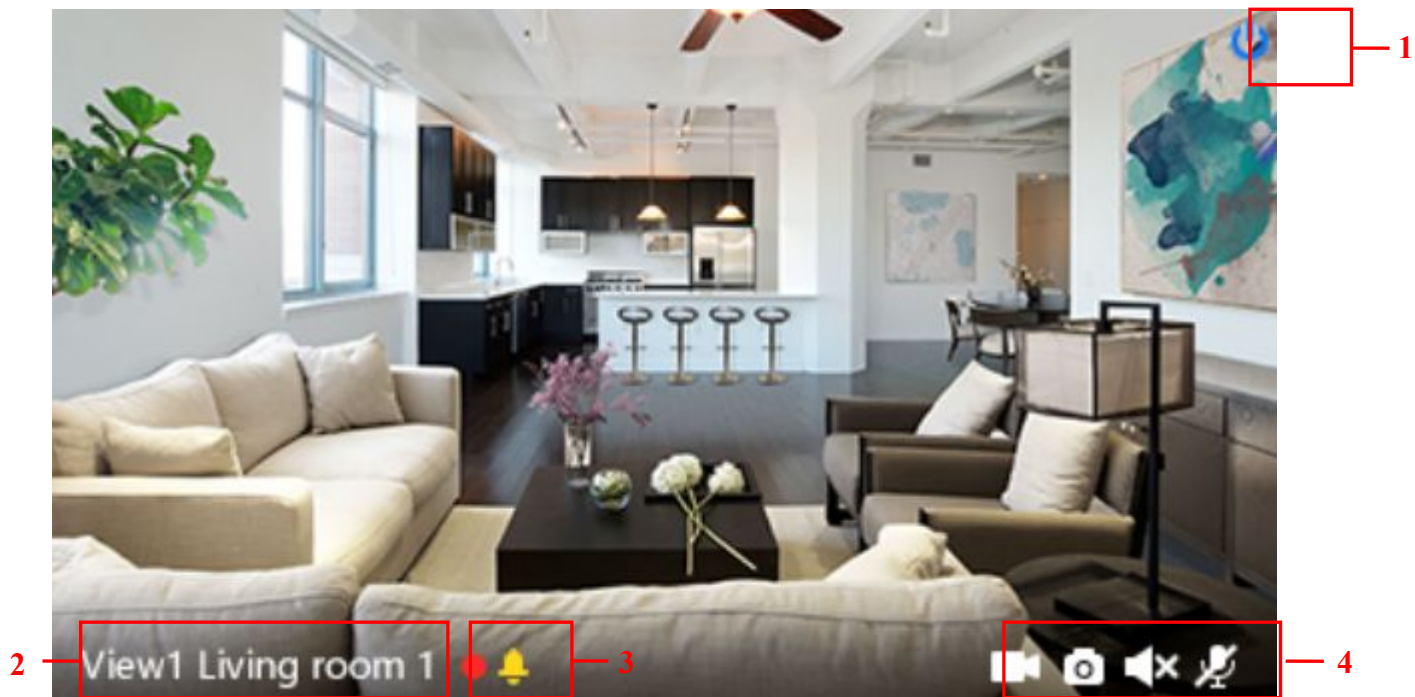

1-----Close

Click the icon to close this channel live window

2-----Device Name

Show view channel and camera name.

3-----Recording and Alarm status

 This icon will turn to red, it indicates that the camera is recording

 This icon will turn to yellow, the motion is detected during the detection time in the detection area, the camera alarm and adopt the corresponding alarm indicators

4----- Record / Snap Shot / Sound / Talk button

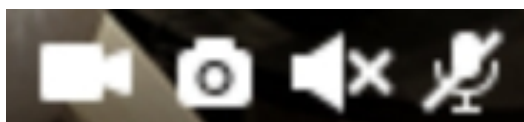

Record Snap Shot Sound Talk

Record ----- Click it and do manually recording. When recording, icon 1 will turn to blue. Click it again and stop recording. The recording files will be stored to C disk automatically

Snap Shot ----- Click it to make snapshot. After snapshot, the button banner will prompt **Captured Successfully**. And you can find the picture on default path C:\VMS_CAPTURE

Snapshot

```
Success, Picture:
C:\VMS_CAPTURE
\MDS2010_A0E6FB6FAB01\20191014
\2019-10-14_17_15_46.bmp
```

Sound ----- Click the icon then you will hear sound captured by the camera's built-in microphone. You may

need to plug in earphones or enable the computer speakers to hear from the camera's microphone. Make sure the camera supports audio. Click again and stop audio.

Talk ----- Click the button, then talk to the microphone that connected with PC, people around the camera can here you voice. Click the icon again and stop talking.

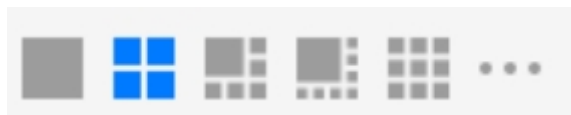

Section4 The number of split-screen

Click this button to select the number of split-screen on one page.





The client can monitor many cameras at one page, here you can choose the display number. The maximum number is 16.

Section5 Live Cruise / Close All / Full Screen / Hide Bar

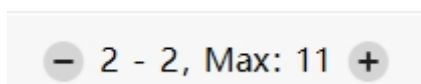
 **Live Cruise** ----- Click this button to Live Cruise, you can click  button to add a loop page for live Cruise or click  button to reduce the loop page for live Cruise.



 **Close All** ----- Click this button to close all the cameras

 **Full Screen** ----- Click this button to enter full screen, Click this button to enter full screen, then click to exit full screen.

 **Hide Bar** ----- Click this button, Hide and show Pan / Tilt control Bar

Section6 Spotlight / Siren / Display / Night Vision

Spotlight: You can set Spotlight.

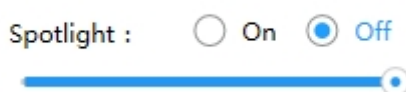

Siren: You can set Siren.



Display: You can set HDR and Mirror.

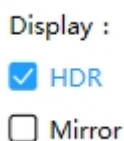

Night Vision: You can set Night Vision.

Night Vision :

- Auto
- On
- Off
- Schedule

3.5 Advanced Camera Settings

Click  the button, goes to Device Settings to make advanced camera settings.

3.5.1 Status

Status contains two columns: Device Information and Logs, it will show you various information about your camera.

3.5.1.1 Device Information

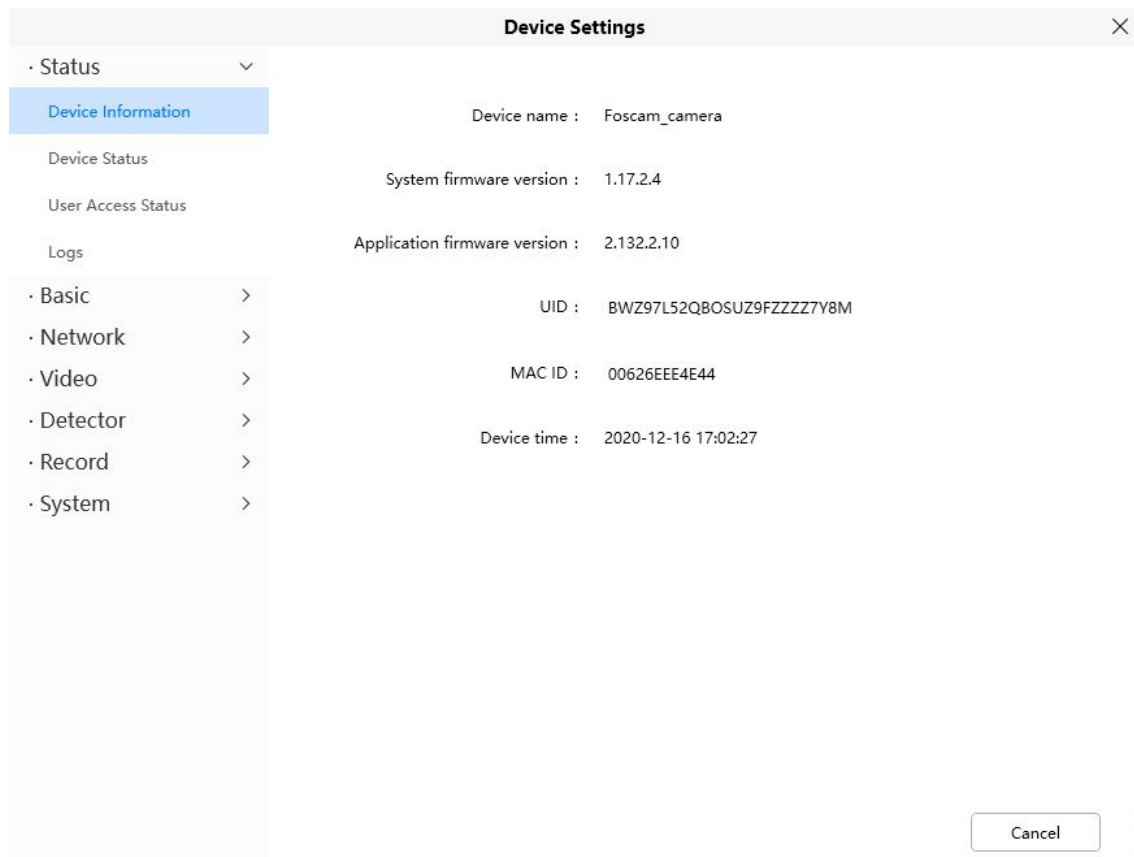

Device Name: The Device Name is a unique name that you can give to your device to help you identify it. Click Basic Settings and go to Camera Name panel where you can change your camera name. The default device name is Foscam_camera.

System Firmware Version: Display the System Firmware version of your camera.

App Firmware Version: Display the application firmware version of your camera.

MAC ID: Display the MAC address of your camera. For example Device ID is 00626EE96E3C, the same MAC ID sticker is found at the bottom of the camera.

Device Time: The system time of the device. Click Basic Settings and go to Device Time panel and adjust the time.

3.5.1.2 Device Status

On this page you can see device status such as Alarm status, NTP status, IR LED Status and so on.

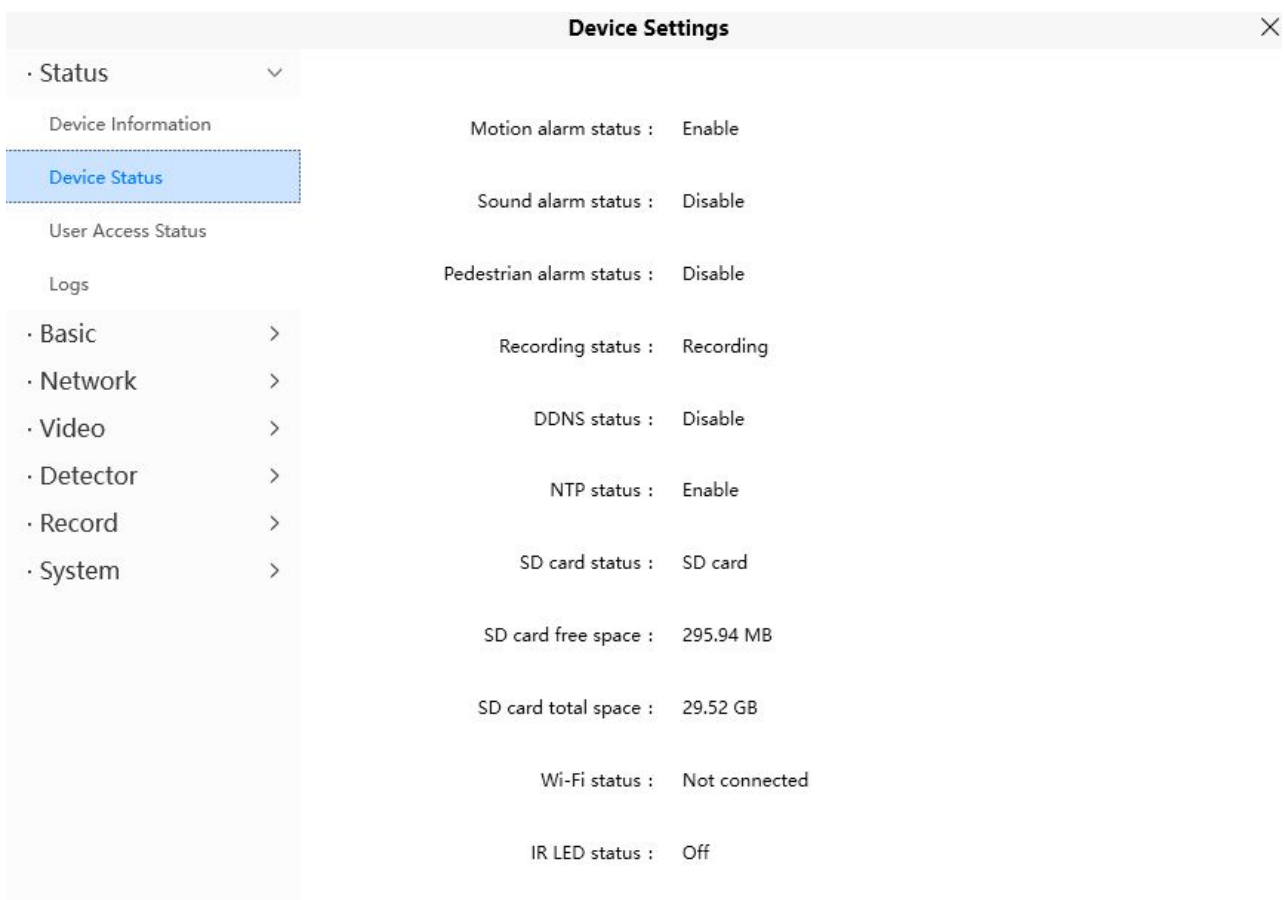

3.5.1.3 User Access Status

Session status will display who and which IP is visiting the camera now

Device Settings [X]

- Status
 - Device Information
 - Device Status
 - User Access Status**
 - Logs
- Basic >
- Network >
- Video >
- Detector >
- Record >
- System >

User	IP
1	192.168.1.29
1	192.168.1.123

[Cancel]

3.5.1.4 Logs

The log record shows who and which IP address accessed or log out the camera.

Device Settings

- Status
 - Device Information
 - Device Status
 - User Access Status
 - Logs**
 - Basic >
 - Network >
 - Video >
 - Detector >
 - Record >
 - System >

No.	Time	User	IP	Log
1	2020-12-16 17:04:27	root	127.0.0.1	Motion Detection
2	2020-12-16 17:04:02	root	127.0.0.1	Motion Detection
3	2020-12-16 17:03:49	root	127.0.0.1	Motion Detection
4	2020-12-16 17:03:03	root	127.0.0.1	Motion Detection
5	2020-12-16 17:02:51	root	127.0.0.1	Motion Detection
6	2020-12-16 17:02:39	root	127.0.0.1	Motion Detection
7	2020-12-16 17:02:21	root	127.0.0.1	Motion Detection
8	2020-12-16 17:02:05	root	127.0.0.1	Motion Detection
9	2020-12-16 17:01:48	root	127.0.0.1	Motion Detection
10	2020-12-16 17:01:38	root	127.0.0.1	Motion Detection
11	2020-12-16 17:01:19	root	127.0.0.1	Motion Detection
12	2020-12-16 17:01:00	root	127.0.0.1	Motion Detection
13	2020-12-16 17:00:50	root	127.0.0.1	Motion Detection
14	2020-12-16 17:00:40	root	127.0.0.1	Motion Detection
15	2020-12-16 17:00:26	root	127.0.0.1	Motion Detection
16	2020-12-16 16:59:35	root	127.0.0.1	Motion Detection
17	2020-12-16 16:59:25	root	127.0.0.1	Motion Detection
18	2020-12-16 16:59:14	root	127.0.0.1	Motion Detection
19	2020-12-16 16:59:03	root	127.0.0.1	Motion Detection
20	2020-12-16 16:58:52	root	127.0.0.1	Motion Detection

Total 41 Pages

[Go]

Click the page number and go to the corresponding page to see more logs

Full in one page number, click go GO button and go to the corresponding page.

3.5.2 Basic

This section allows you to configure your Device Name, Time, User Accounts, Status Light and Voice Prompt.

3.5.2.1 Camera Name

Default alias is Foscam_camera. You can define a name for your camera here such as apple. Click Save to save your changes. The alias name cannot contain special characters.

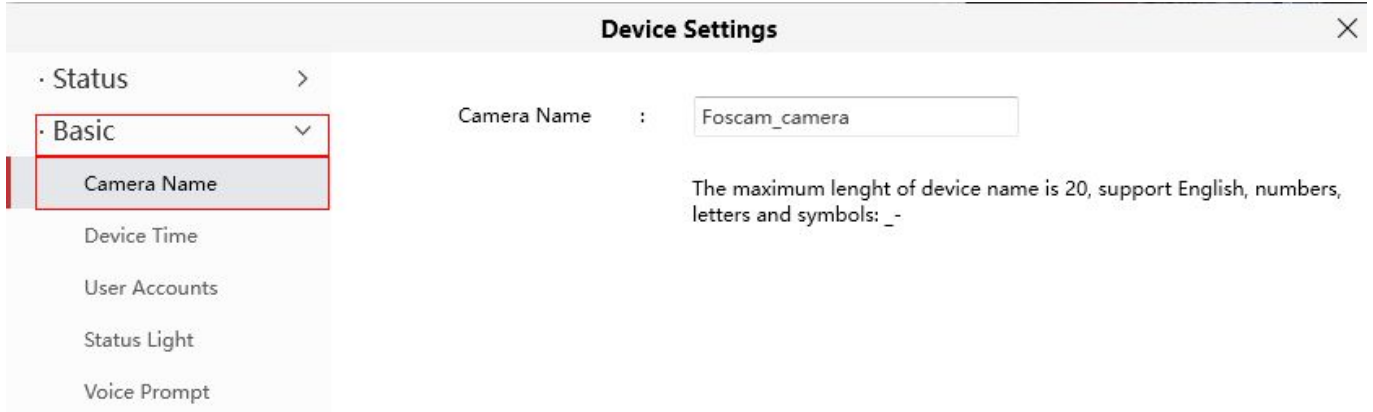

The screenshot shows the 'Device Settings' window with a sidebar on the left containing a menu with 'Basic' selected and 'Camera Name' highlighted. The main area shows 'Camera Name' set to 'Foscam_camera' in a text input field. Below the field is a note: 'The maximum length of device name is 20, support English, numbers, letters and symbols: _-'. The window has a close button in the top right corner.

3.5.2.2 Device Time

This section allows you to configure the settings of the internal system clock for your camera.

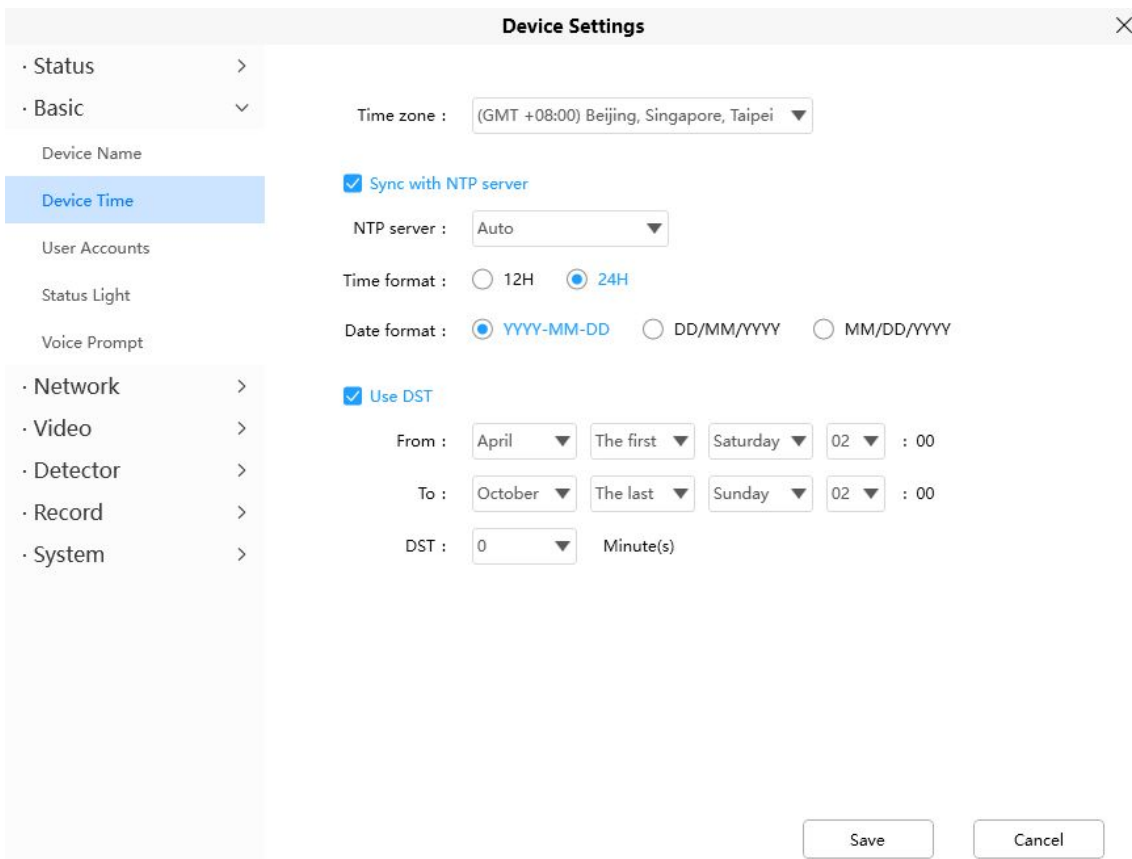

The screenshot shows the 'Device Settings' window with 'Device Time' selected in the sidebar. The main area contains the following settings: 'Time zone' set to '(GMT +08:00) Beijing, Singapore, Taipei'; 'Sync with NTP server' checked; 'NTP server' set to 'Auto'; 'Time format' set to '24H'; 'Date format' set to 'YYYY-MM-DD'; 'Use DST' checked; 'From' set to 'April, The first, Saturday, 02 : 00'; 'To' set to 'October, The last, Sunday, 02 : 00'; and 'DST' set to '0 Minute(s)'. 'Save' and 'Cancel' buttons are at the bottom right.

Time Zone: Select the time zone for your region from the drop down menu.

Sync with NTP server: Network Time Protocol will synchronize your camera with an Internet time server. Choose the one that is closest to your camera.

Use DST: Select the **use DST** (Daylight Saving Time, to set the clock ahead of the real-time), then set the start time and end time of the DST, select the daylight saving time from the drop-down menu at last.

Click **Save** button and submit your settings.

3.5.2.3 User Accounts

Here you can create users and set privilege, visitor, operator or administrator. The default administrator user accounts are administrator with a blank password.

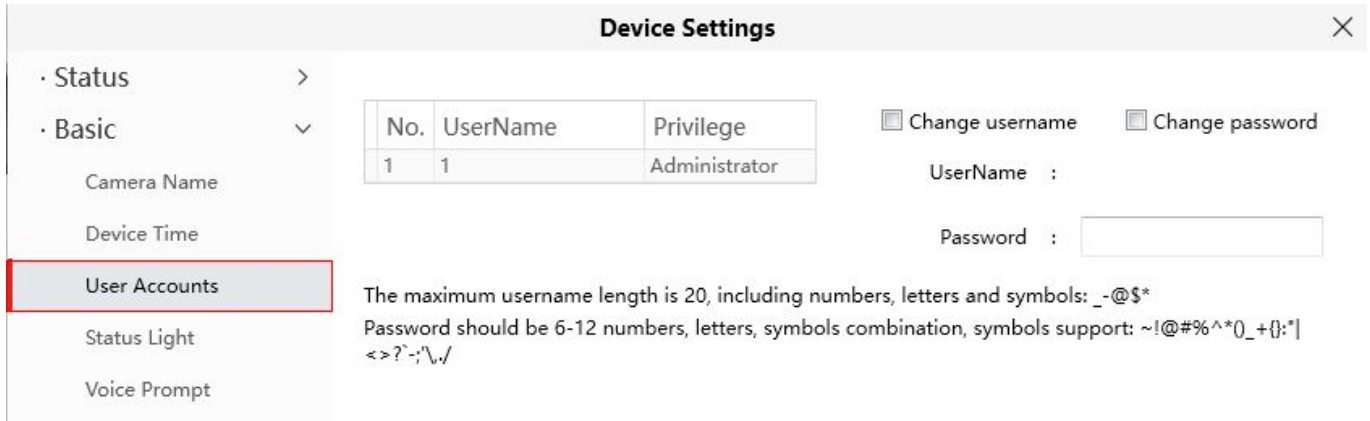

How to change the password?

Firstly, select the account which you want to change the password, then select **Change password**, enter the old password and the new password, lastly click modify to take effect.

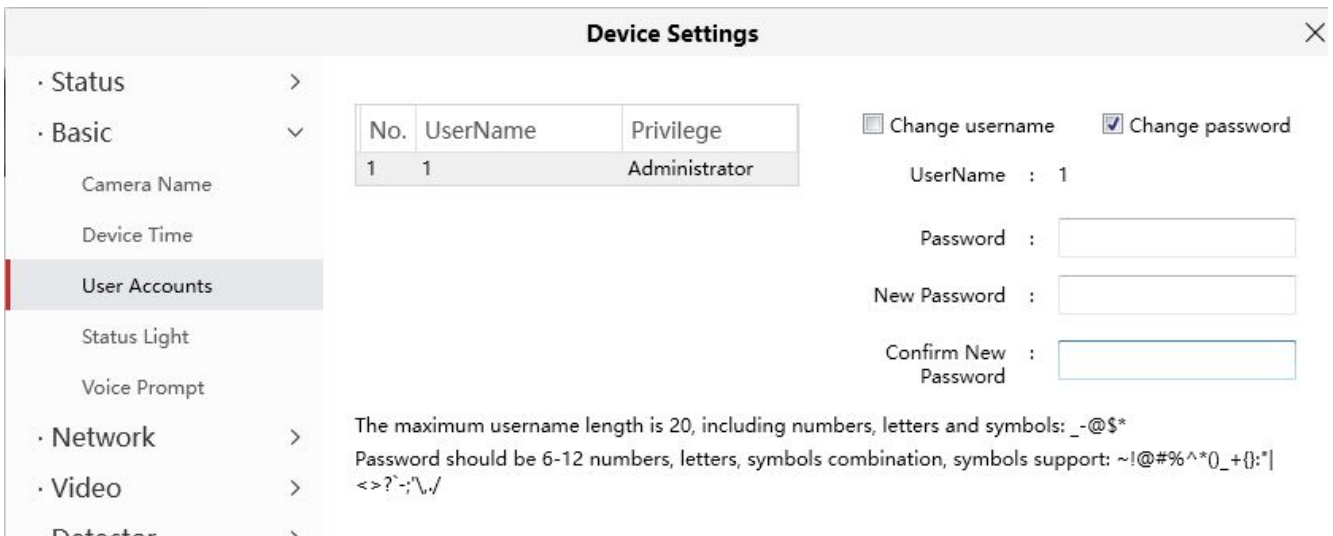

How to change the username?

Select the account which you want to change the username, then select Change username, enter the new username and the password, lastly click modify to take effect.

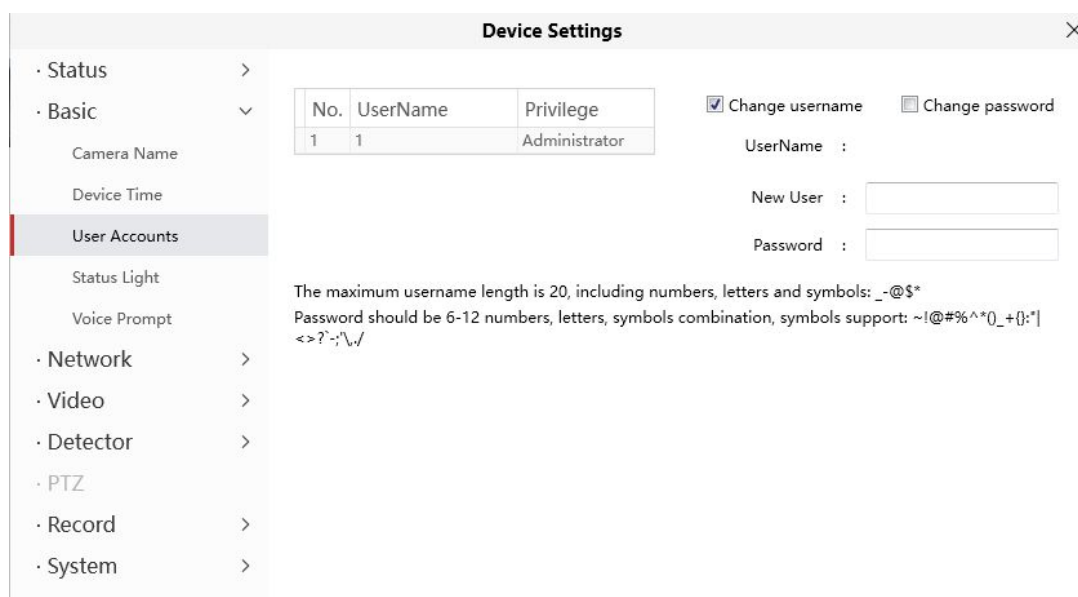

3.5.2.4 Status Light

If you have a power and network status light on your camera, you can turn it on and off with this feature. This camera don't have the status light described above.

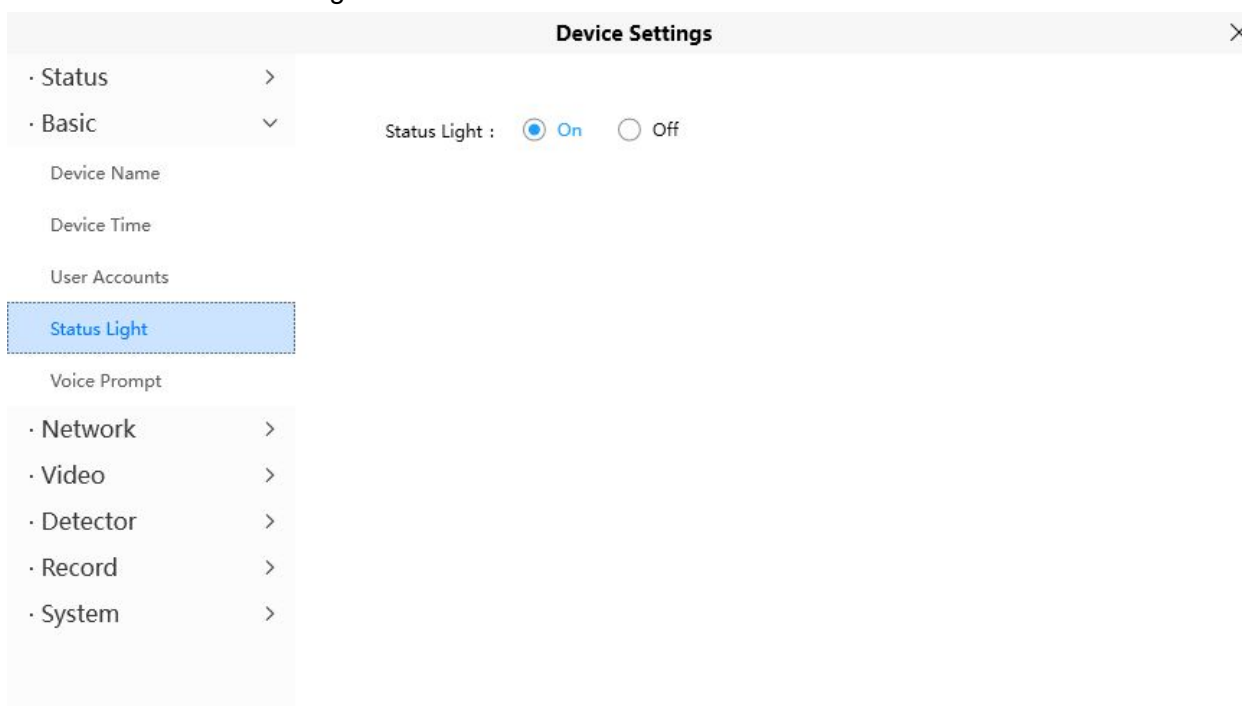

3.5.2.5 Voice Prompt

You can set the voice prompt on the camera to turn on and off if you connect an external audio device.

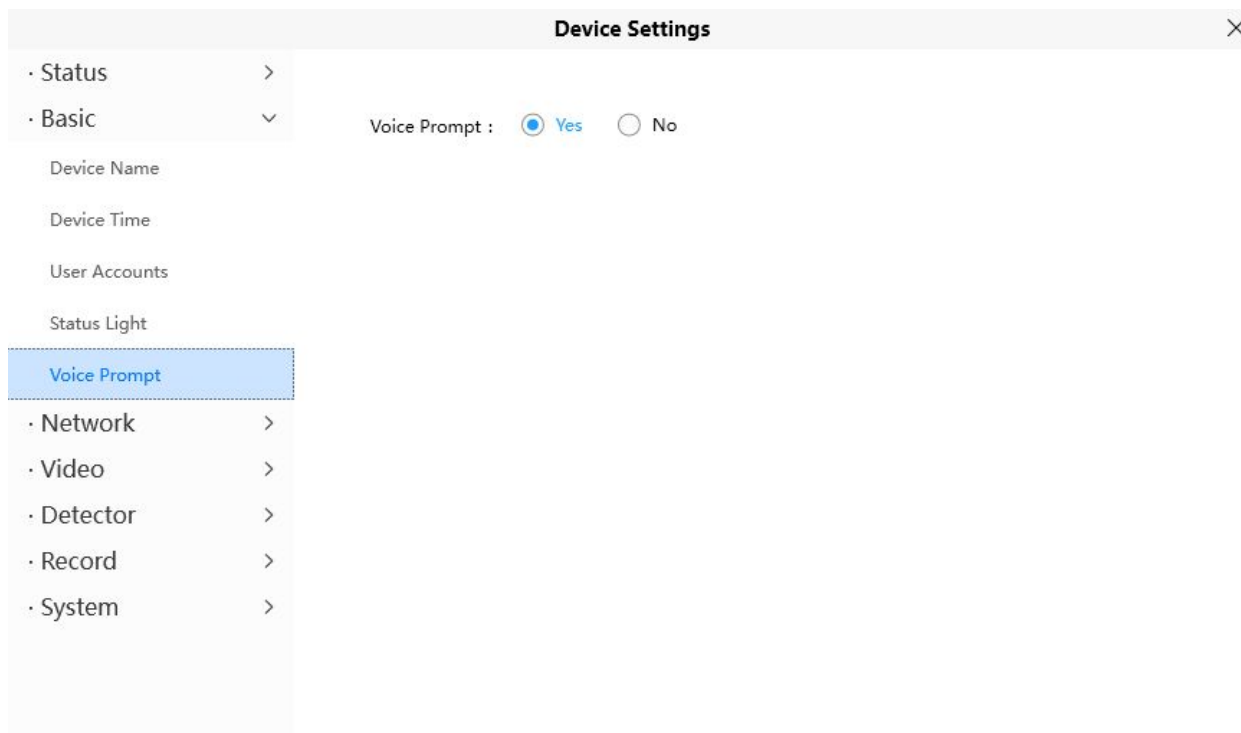

3.5.3 Network

This section will allow you to configure your camera's information.

3.5.3.1 IP

If you want to set a static IP for the camera, please go to **IP** page. Keep the camera in the same subnet of your router or computer.

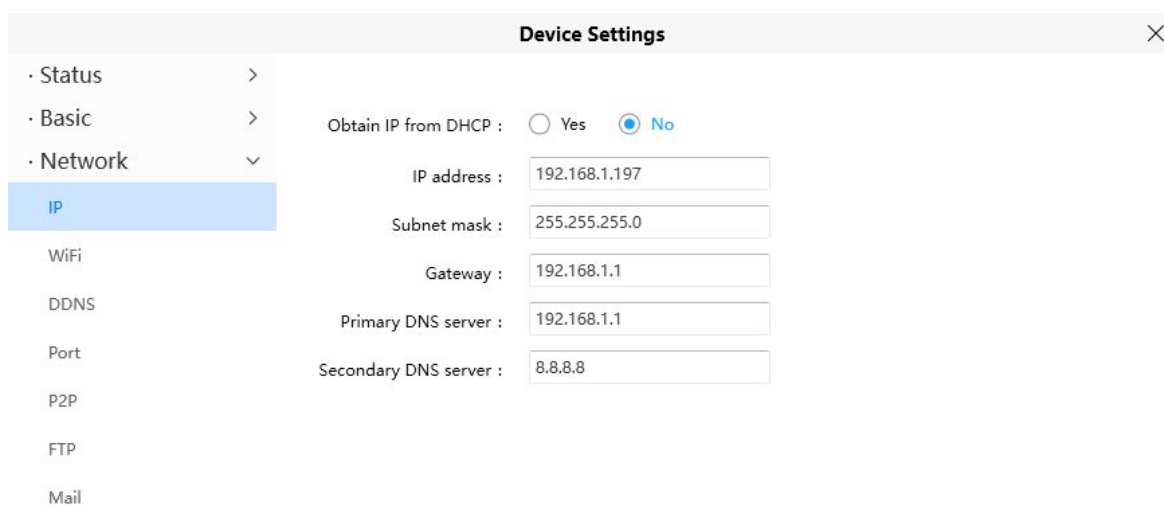

It is recommended that you use the subnet mask, gateway and DNS server from your locally attached PC. If you don't know the subnet mask, gateway and DNS server, you can check your computer's local area connection as follows:

Control Panel--Network Connections--Local Area Connections --Choose Support--Details.

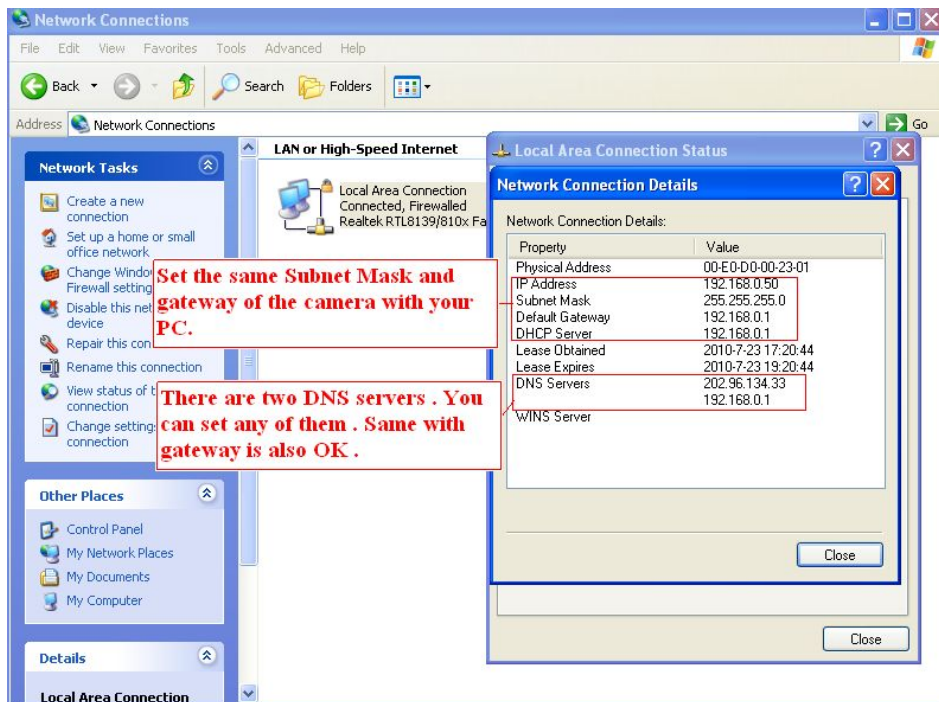
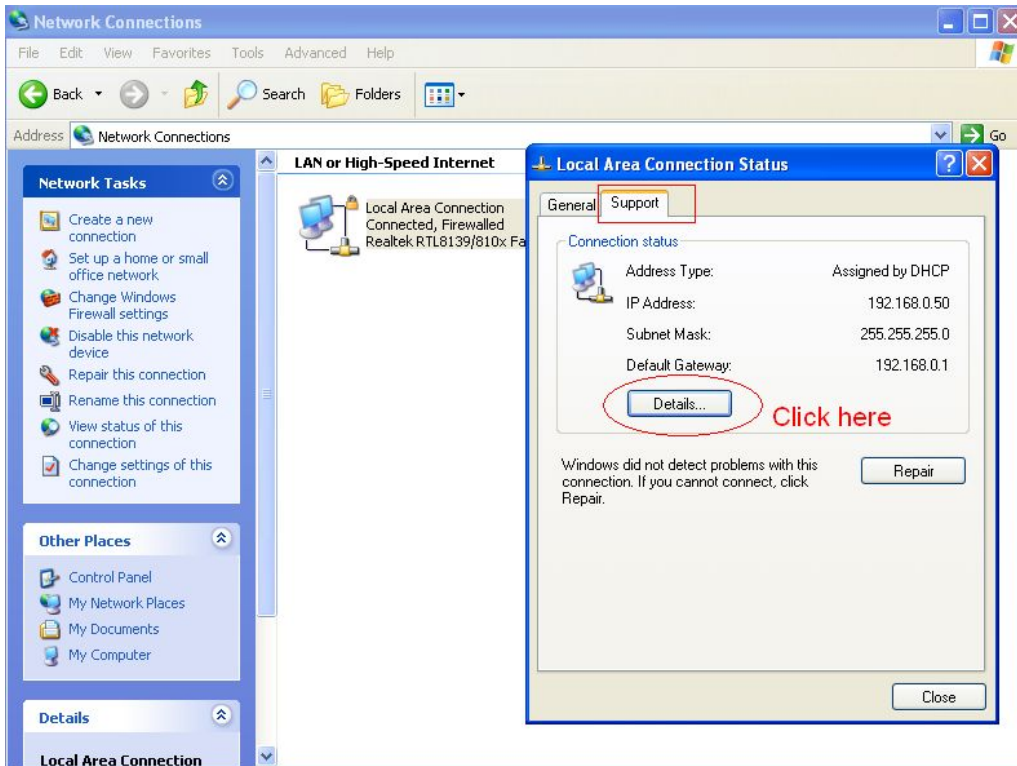

If you don't know the DNS server, you can use the same settings as the Default Gateway.

3.5.3.2 WiFi

Step 1: Click the Scan button and the camera will detect all wireless networks around the area. It should also display your router in the list.

Device Settings

· Status >
· Basic >
· Network >
 IP
 WiFi
 DDNS
 Port
 P2P
 FTP
 Mail
· Video >
· Detector >
· Record >
· System >

Wireless network : Scan

Click the Scan button to search for wireless networks.

No.	SSID	Encryption	Signal
1	Xiaomi_49AB_5		
2	Xiaomi_49AB		
3	FOSCAM		
4	zx123456789	WPA/WPA2	📶
5	FOSCAM_5G	WPA2	📶
6	FYCT	WPA/WPA2	📶
7	QL-C1	WPA/WPA2	📶
8	TP-LINK_B19648	None	📶
9	qiyongkun	WPA/WPA2	📶
10	QC7	WPA/WPA2	📶
11	TP-LINK-LIKAIZHOU	WPA/WPA2	📶
12	Evan_test5G	WPA/WPA2	📶
13	Foscam_wzl	WPA/WPA2	📶
14	PN	WPA2	📶
15	foscam_zzy	WPA/WPA2	📶
16	Foscam-test	WPA/WPA2	📶

SSID :
Encryption :
Password :
Test :

To ensure the Wi-Fi switch takes effect, the device will restart.

Step 2: Click the SSID (name of your router) in the list, the corresponding information related to your network, such as the name and the encryption, will be filled into the relevant fields automatically. You will only need to fill in the password of your network. Make sure that the SSID, Encryption and the password you filled in are exactly the same for your router.

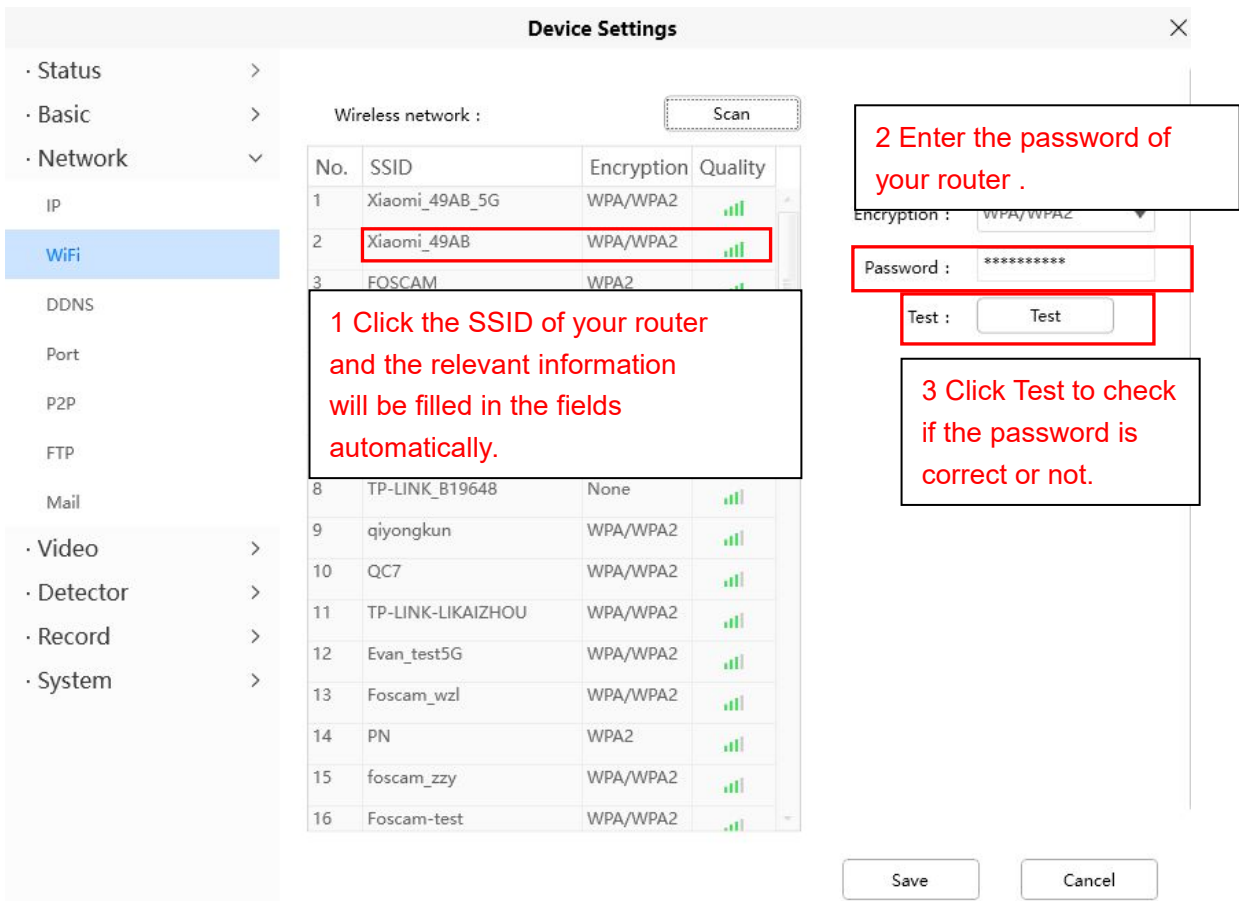

Step 3: Please click on the Save button after all settings have been entered and disconnect the network cable. Never shut down the power of the camera until the IP camera is able to connect to the wireless network. The LAN IP address will disappear on the window of Add Device when the camera is configuring a wireless connection. Wait about 1 minute, the camera should obtain a wireless connection, and the LAN IP of the camera will show again on the window of Add Device. The IP address may have changed after the camera receives a wireless connection; we recommend setting a static local IP address if this IP address changes by right clicking the camera in Equipment Search Tool, setting a static IP, and pushing OK . Congratulations! You have set up the wireless connection of the camera successfully.

NOTE: If you fail to make a wireless connection, please refer to your seller or contact us directly for assistance.

3.5.3.3 DDNS

FOSCAM cameras can use third-party domain names. You can choose the corresponding third-party domain name.

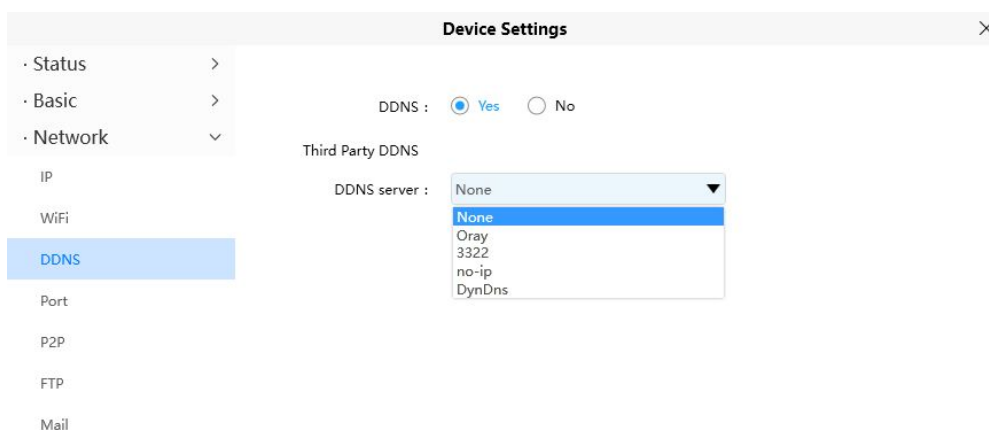

3.5.3.4 Port

This camera supports HTTP Port / HTTPS Port/ ONVIF Port. HTTP Port is used to access the camera remotely.

HTTP port: By default, the HTTP is set to 88. Also, they can be assigned with another port number between 1 and 65535. But make sure they can not be conflict with other existing ports like 25, 21.

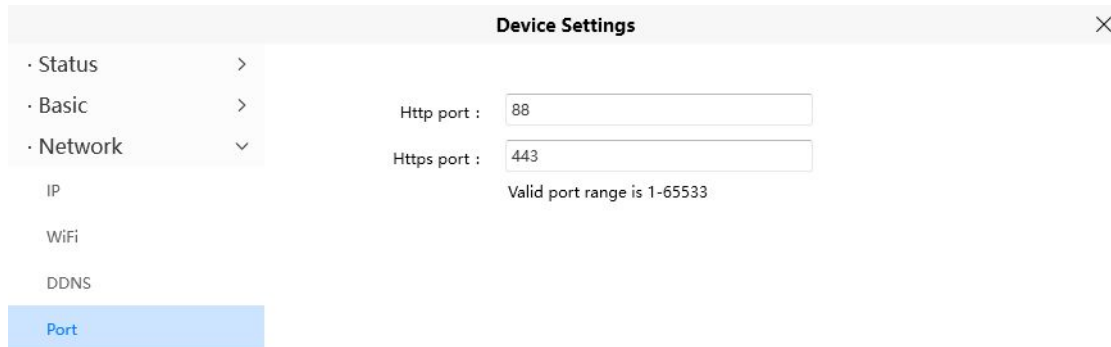

3.5.3.5 P2P

Access the camera by smart phone (Android or iOS operating system)

First of all, you need to open the P2P function of the camera at  > **Network** > **P2P**.

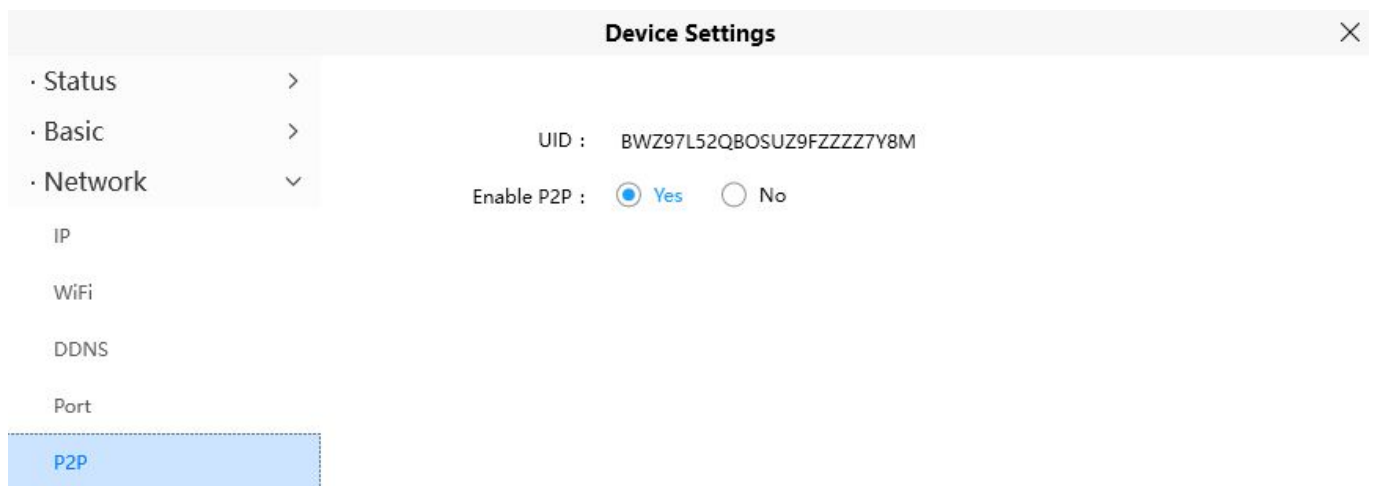

3.5.3.6 FTP

If you want to upload record images to your FTP server, you can set **FTP**.

Device Settings [X]

- Status >
- Basic >
- Network ▾
 - IP
 - WiFi
 - DDNS
 - Port
 - P2P
 - FTP**
 - Mail
 - Video >
 - Detector >
 - Record >
 - System >

FTP server :
 Example: ftp://192.168.1.103/dir
 The maximum length of the address is 127, does not support the character: =&

Port :

Mode : PASV Port

Username :
 The maximum length of the user name is 63, support numbers, letters and symbols: _@\$*.,#%~!

Password :
 The maximum length of the password is 63, support numbers, letters and symbols: ~!@#%^^^{}_+{|<>?`-:\./&=[]

FTP server: If your FTP server is located on the LAN, you can set as Figure a.

If you have an FTP server which you can access on the internet, you can set as Figure b.

Port: Default is port 21. If changed, external FTP client program must change the server connection port accordingly.

Mode: Here supports two modes: PORT and PASV.

Username / password: The FTP account and password.

Click **Save** to take effect.

Click **Test** to see if FTP has been successfully configured.

3.5.3.7 Mail Settings

If you want the camera to send emails when motion has been detected, here Mail will need to be configured.

Device Settings

- Status >
- Basic >
- Network >
 - IP
 - WiFi
 - DDNS
 - Port
 - P2P
 - FTP
 - Mail**
 - Video >
 - Detector >
 - Record >
 - System >

Enable mail : Yes No

Smtip server :
 Example: smtp.sample.com
 Smtip server address supports English, numbers and @_,- **1**

Smtip port :

Transport layer security :

G-Mail only supports TLS at Port 465 and STARTTLS at Port 587 or 25. Hotmail only supports STARTTLS at Port 587 or 25.

Need authentication :

Smtip account :
 Example: someone@sample.com
 The maximum length of email is 63, support numbers, letters and symbols: @_.\$*- **2**

Smtip password :
 The maximum length of the password is 16, including numbers, letters and symbols: ~!@#%^*()_+{}|<>?~\./

Mail sender : **3** **6**
 Example: someone@sample.com

Mail recipient 1 : **4**
 Example: someone@sample.com

5

1----- SMTP Server/ Port /Transport Layer Security Enter SMTP server for sender. SMTP port is usually set as 25. Some SMTP servers have their own port, such as 587 or 465, and Transport Layer Security usually is None. If you use Gmail, Transport Layer Security must be set to TLS or STARTTLS and SMTP Port must be set to 465 or 25 or 587, which port you choose should be decided by which Transport Layer Security you select.

2----- SMTP Account/ password ID account and password of the sender email address

3----- E-mail Sender Mailbox for sender must support SMTP

4----- Receiver Mailbox for receiver need not support SMTP, you can set 4 receivers

5----- Save Click Save to take effect

6----- Test Click Test to see if Mail has been successfully configured.

Click **Test** to see if Mail has been successfully configured.

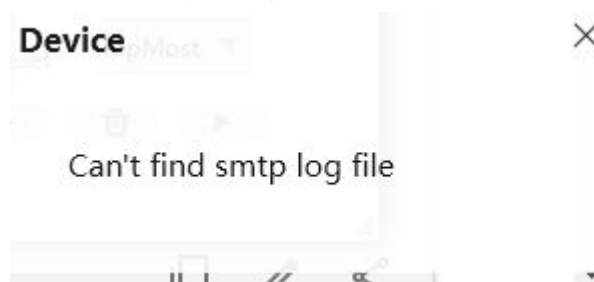

If the test success, you can see the Success behind the Test, at the same time the receivers will receive a test mail.

If the test fails with one of the following errors after clicking Test, verify that the information you entered is correct and again select Test .

- 1) Cannot connect to the server
- 2) Network Error. Please try later
- 3) Server Error
- 4) Incorrect user or password
- 5) The sender is denied by the server. Maybe the server need to authenticate the user, please check it and try again
- 6) The receiver is denied by the server. Maybe because of the anti-spam privacy of the server
- 7) The message is denied by the server. Maybe because of the anti-spam privacy of the server
- 8) The server does not support the authentication mode used by the device.

3.5.4 Video

This section allows you to configure Video Encode settings, On screen display, Snapshot and IR LED settings.

3.5.4.1 Video Encode

This is main Encode video settings.

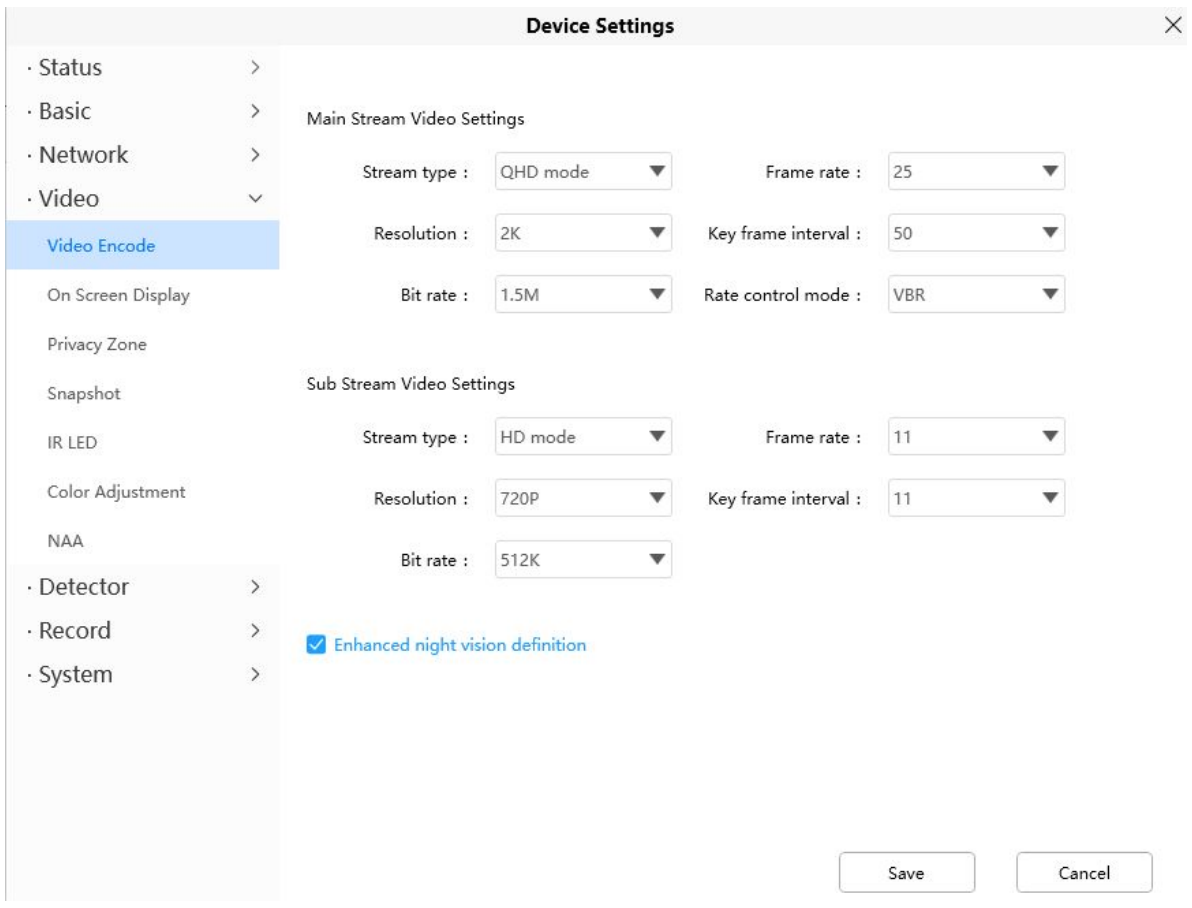

Stream type: There are four types to identify different streams you have set.

Resolution: The camera supports multiple types, For example: 2K,3M,1080P, 720P, VGA. The higher the resolution is, the clearer video will become. But the code flux will become larger too, and it will take up more bandwidth. (Different models support different specific types.)

Bit Rate: Generally speaking, the larger the bit rate is, the clearer video will become. But the bit rate configuration should combine well with the network bandwidth. When the bandwidth is very narrow, and bit rate is large, that will lead to video can not play well.

Frame Rate: Note that a larger frame size takes up more bandwidth. When the video format is 50Hz, the maximum frame rate is 25 fps. When the video format is 60Hz, the maximum frame rate is 30 fps. You should lower frame rate when the bandwidth is limited. Normally, when the frame rate above 15, you can achieve fluently video.

Key Frame Interval: The time between last key frame and next key frame. The shorter the duration, the more likely you will get a better video quality, but at the cost of higher network bandwidth consumption.

Variable Bitrate: Select the Bit rate type to constant or variable. If select Yes, the camera will change the video bit rate according to the situation, but will not more than the maximum parameter "Bit Rate"; If select **No**, the Bit Rate is unchanged.

3.5.4.2 On Screen Display

This page is used to add time stamp and device name on the video.

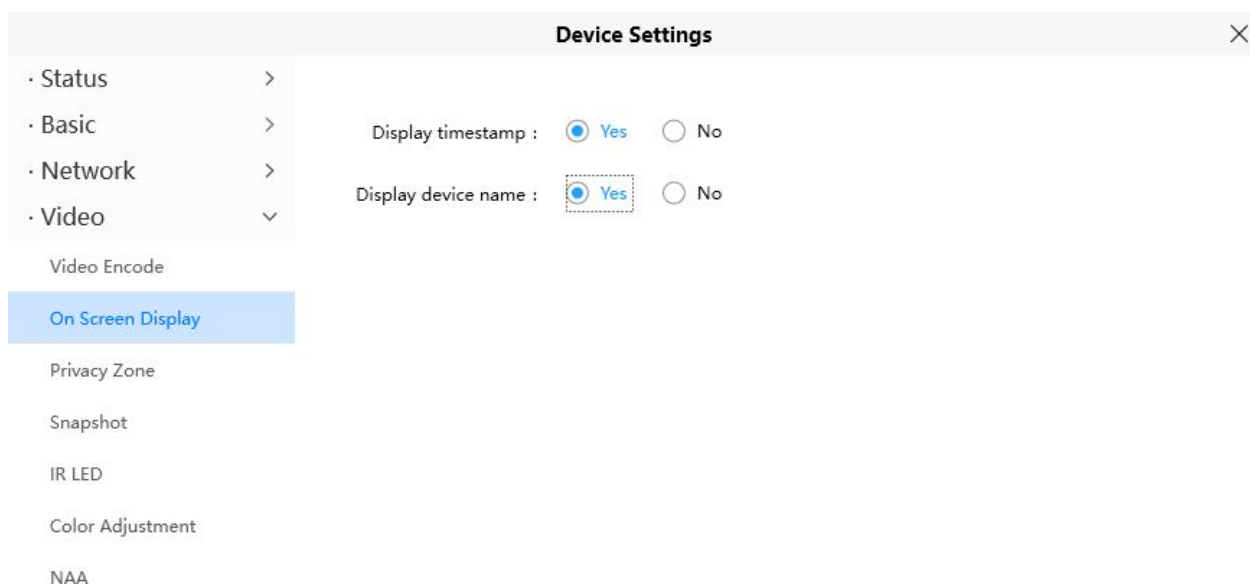

Display Timestamp: There are two options: Yes or NO. Select Yes and you can see the system date on the video,

Display Camera Name: There are two options: Yes or NO. Select Yes and you can see the device name on the video.

3.5.4.3 Privacy

This page is used to set some mask as privacy zone on the video.

Privacy Zone: Allow On Screen Display Mask, there are two options, Yes or NO.

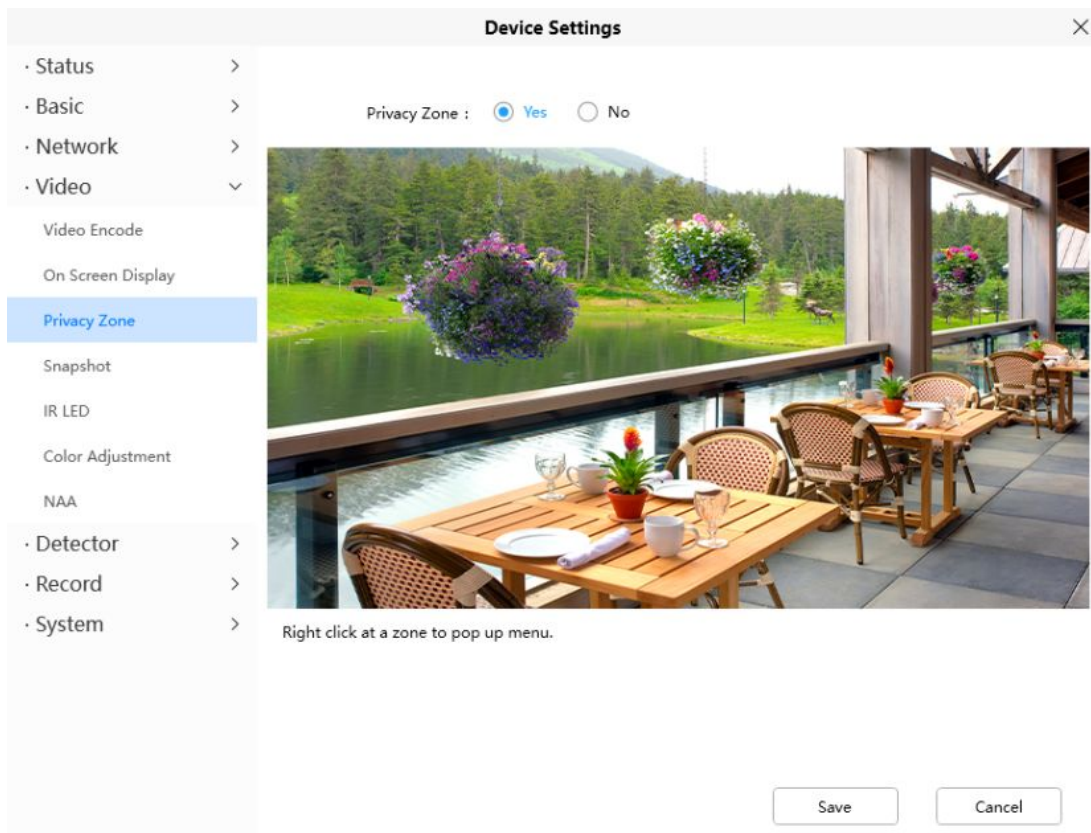

Select Yes and draw a mask area on the video, the mask area will be black on the video.

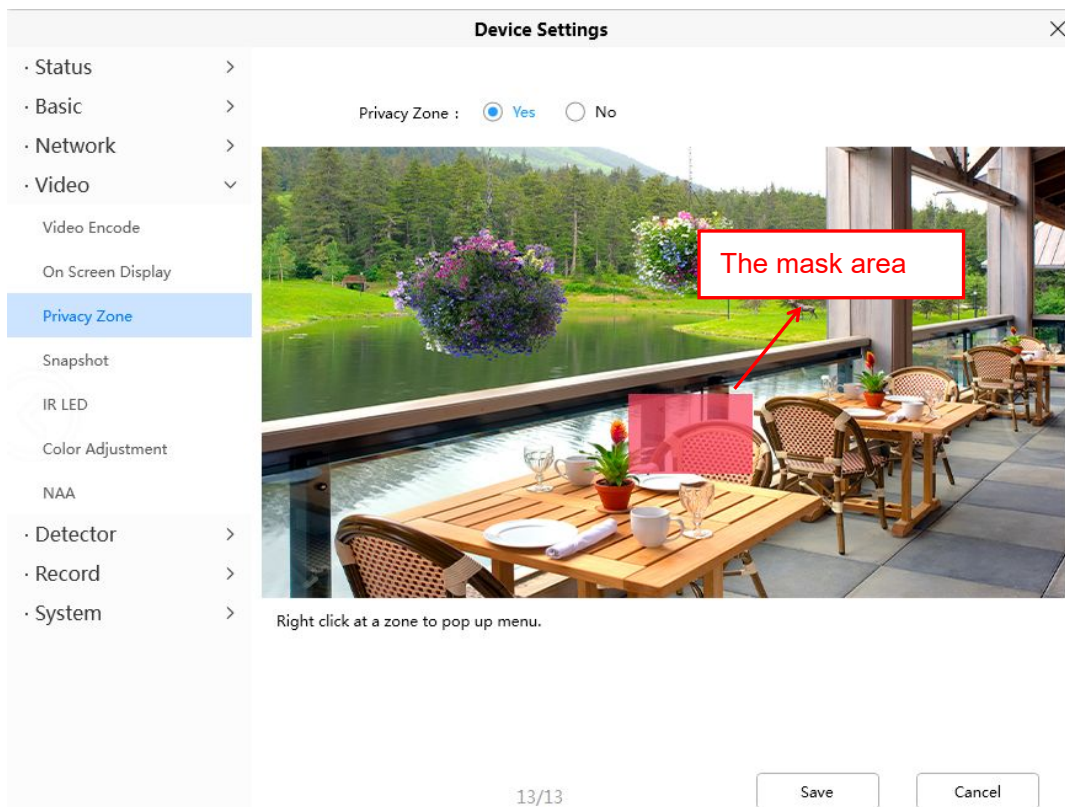

Click Save button and return to the Privacy Zone page, click Save to take effect.
 Back to the surveillance window, you can see the mask area as the following picture.



3.5.4.4 Snapshot

On this page you can set the snapshot pictures' image quality and the storage path.

Device Settings ✕

- Status >
- Basic >
- Network >
- Video >
- Video Encode
- On Screen Display
- Privacy Zone
- Snapshot
- IR LED
- Color Adjustment
- NAA
- Detector >
- Record >
- System >

Manual snap quality : Low Medium High

Pictures save to : None SD card FTP

Enable timing to capture

Capture interval : (5s-65535s)

Schedule

All	0	1	2	3	4	5	6	7	8	9	10	11	12	13	14	15	16	17	18	19	20	21	22	23
Mon.																								
Tues.																								
Wed.																								
Thur.																								
Fri.																								
Sat.																								
Sun.																								

Manual Snap Quality: Low, Middle and High. The higher the quality, the picture will be clearer.
Pictures Save To: FTP. If you have done FTP and Alarm settings, when alarming, the camera will snap pictures to the FTP automatically. If you select the FTP, you can set the file name which the picture save to.

Enable Timing to Capture

To enable capture interval, follow the steps below:

1 Select Enable timing to capture

2 Capture interval: The interval time between two captures.

3 Select the capture time

- Capture anytime

Click the black button up the MON, you will see all time range turn red. When something moving in the detection area at anytime, the camera will capture.

- Specify an capture schedule

Click the week day words, the corresponding column will be selected. For example, click TUE, the all column of TUE turns to red, that means during Tuesday whole day, the camera will capture.

- Press the left mouse and drag it on the time boxes, you can select the serial area,

4 Click Save button to take effect.



3.5.4.5 IR LED

There are three modes to set the IR LED lights.

Auto: The default mode is auto. On this mode, IR LED lights will be switched automatically depended on the brightness of enviroment.

Manual: On this mode, you can click **On** option to turn on the IR LED lights, and click **Off** option to turn off the IR LED lights.

Schedule: On this mode, IR LED lights will be turned off during the setting schedule .You can set the period of time during which the infrared lamp is turned off to prevent your baby from being influenced during sleep. You can also turn off the infrared lamp on the video preview page at any time.

Device Settings ✕

- Status >
- Basic >
- Network >
- Video ▾
- Video Encode
- On Screen Display
- Privacy Zone
- Snapshot
- IR LED
- Color Adjustment
- NAA

IR LED mode : Auto Manual Schedule

Turn the IR LED off in below time(s):

<input checked="" type="checkbox"/> Schedule1	08 ▾	:	00 ▾	-	18 ▾	:	00 ▾
<input type="checkbox"/> Schedule2	00 ▾	:	00 ▾	-	00 ▾	:	00 ▾
<input type="checkbox"/> Schedule3	00 ▾	:	00 ▾	-	00 ▾	:	00 ▾

3.5.4.6 Color Adjustment

You can adjust the settings to your liking.

Device Settings ✕

- Status >
- Basic >
- Network >
- Video ▾
- Video Encode
- On Screen Display
- Privacy Zone
- Snapshot
- IR LED
- Color Adjustment
- NAA
- HDR

Hue : 50

Brightness : 50

Contrast : 60

Saturation : 48

Sharpness : 35

Default

Power frequency : 50 Hz 60 Hz Outdoor mode

Flip : Mirror :

3.5.4.7 NAA

Enabling NAA(Network Auto-Adaptability) can make IP Camera changing the real-time rate to adapt different network conditions, which can supply better preview experience.

Device Settings ✕

- Status >
- Basic >
- Network >
- Video >
- Video Encode
- On Screen Display
- Privacy Zone
- Snapshot
- IR LED
- Color Adjustment
- NAA

NAA : On Off

NAA (Network Auto-Adaptability) can make IP Camera changing the real-time rate to adapt different network conditions, which can supply better preview experience.

3.5.4.8 HDR

You can choose to turn it on or off according to your own scene.

Device Settings ✕

- Status >
- Basic >
- Network >
- Video >
- Video Encode
- On Screen Display
- Privacy Zone
- Snapshot
- IR LED
- Color Adjustment
- NAA
- HDR

Hue : 50

Brightness : 50

Contrast : 60

Saturation : 48

Sharpness : 35

Default

Power frequency : 50 Hz 60 Hz Outdoor mode

Flip : Mirror :

3.5.5 Detector

3.5.5.1 Motion Detection

IP Camera supports **Motion Detection Alarm**, when the motion has been detected, it will send emails or upload images to FTP.

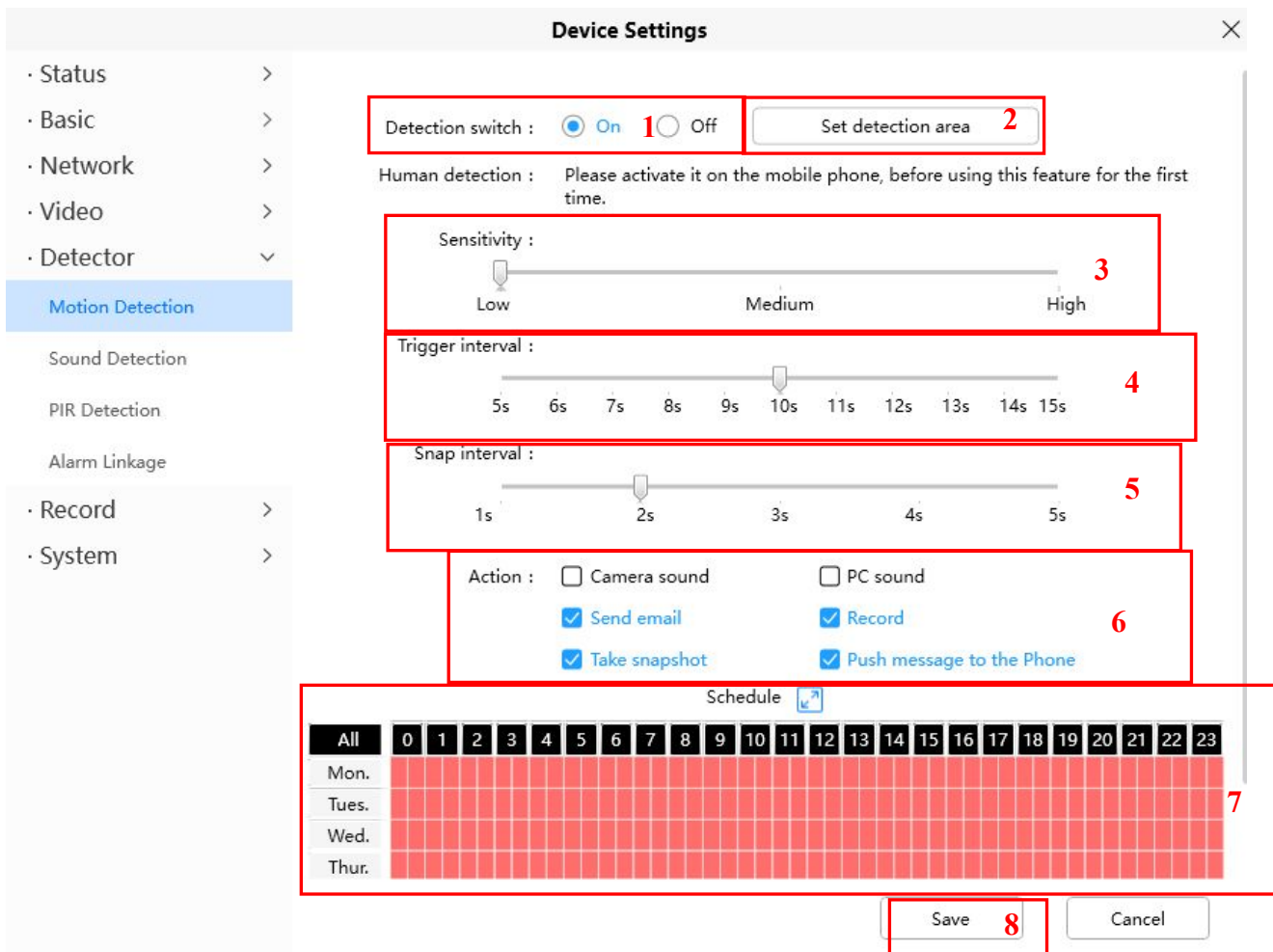

To enable motion detection, follow the steps below:

1 Enable Detection Switch

2 Set detection area You can set the alarm area.

3 Sensitivity---- It supports three modes: Low, Middle and High. The higher the sensitivity, the camera will be more easily alarmed. Select one motion sensitivity.

4 Trigger Interval----The interval time between two motion detections. Here supports 5s/6s/7s/8s/9s/10s/11s/12s/13s/14s/15s. Select one interval time.

5 Snap Interval---- The interval time between two pictures.

6 Select the alarm Action

There are some alarm indicators:

A Camera Sound

If you select Camera Sound, when the motion has been detected, the people around the Camera will hear beep alarm sound, if the device is connected with the audio output device.

B PC Sound

If you select PC Sound, when the motion has been detected, the people around the PC will hear beep alarm sound.

C Send E-mail

If you want to receive alarm emails when motion is detected, you must select Send E-mail and set Mail Settings first.

D Recording

If you select this checkbox, when the motion has been detected, the camera will recording and load it to the FTP server. Make sure you have set FTP and set FTP as the storage path in Video->Snapshot settings panel

E Take Snapshot

If you select this checkbox, when the motion has been detected, the camera will snap the live view window as a still picture and load it to the FTP. Make sure you have set the storage path in **Video > Snapshot Settings** panel.

F Push message to the phone

If you select this checkbox, when the motion has been detected, the camera will push the message to the phone which has been connected the camera.

7 Alarm Schedule

1. Alarm anytime when motion is detected

Click the black button up the MON, you will see all time range turn red. When something moving in the detection area at anytime, the camera will alarm.

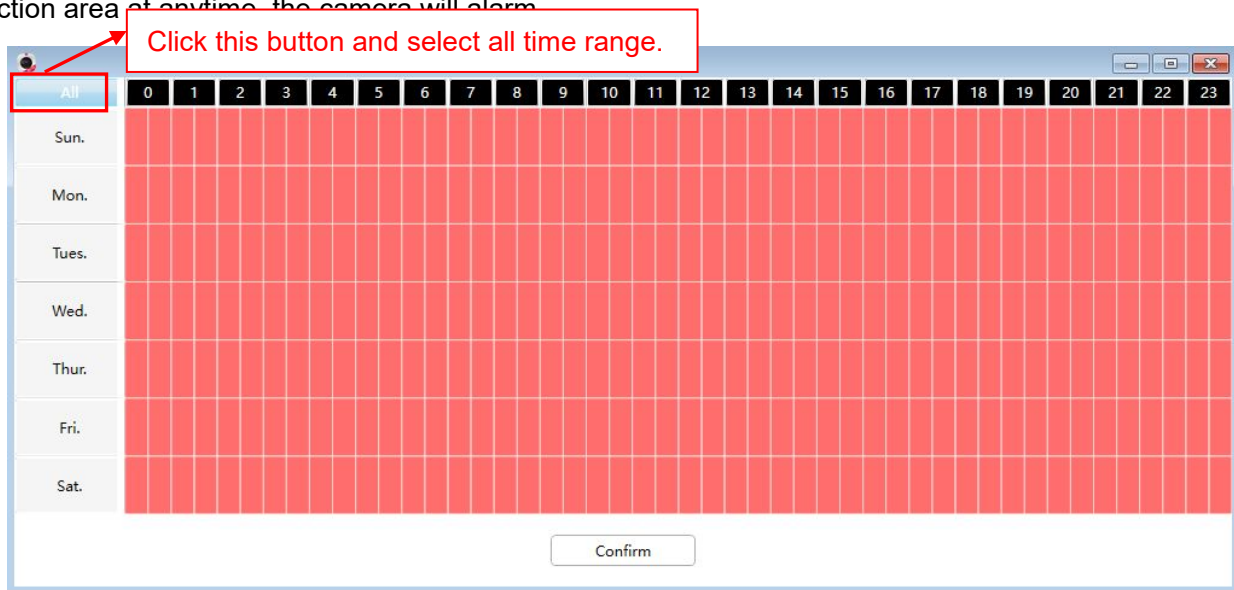

2. Specify an alarm schedule

Click the week day words, the corresponding column will be selected. For example, click TUE, the all column of TUE turns to red, that means during Tuesday whole day, when something moving in the detection area, the camera will alarm.



3. Press the left mouse and drag it on the time boxes, you can select the serial area,

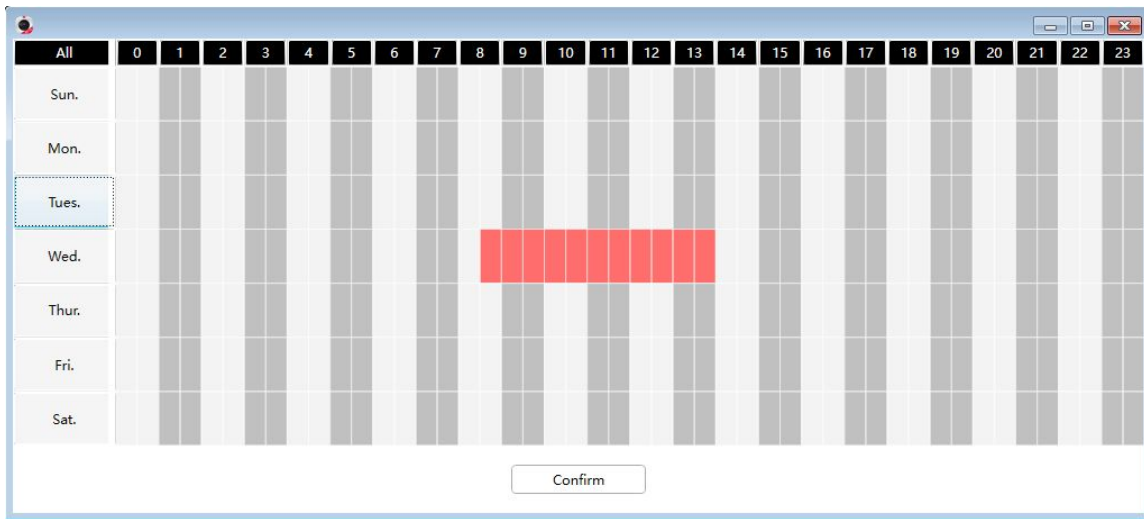

8 Click Save button to take effect. When the motion is detected during the detection time in the detection area, the camera will alarm and adopt the corresponding alarm indicators.

NOTE: You must set the detection area and detection schedule, or else there is no alarm anywhere and anytime.

3.5.5.2 Sound Detection

When the ambient sound over a certain decibel ,the sound alarm will be triggered.

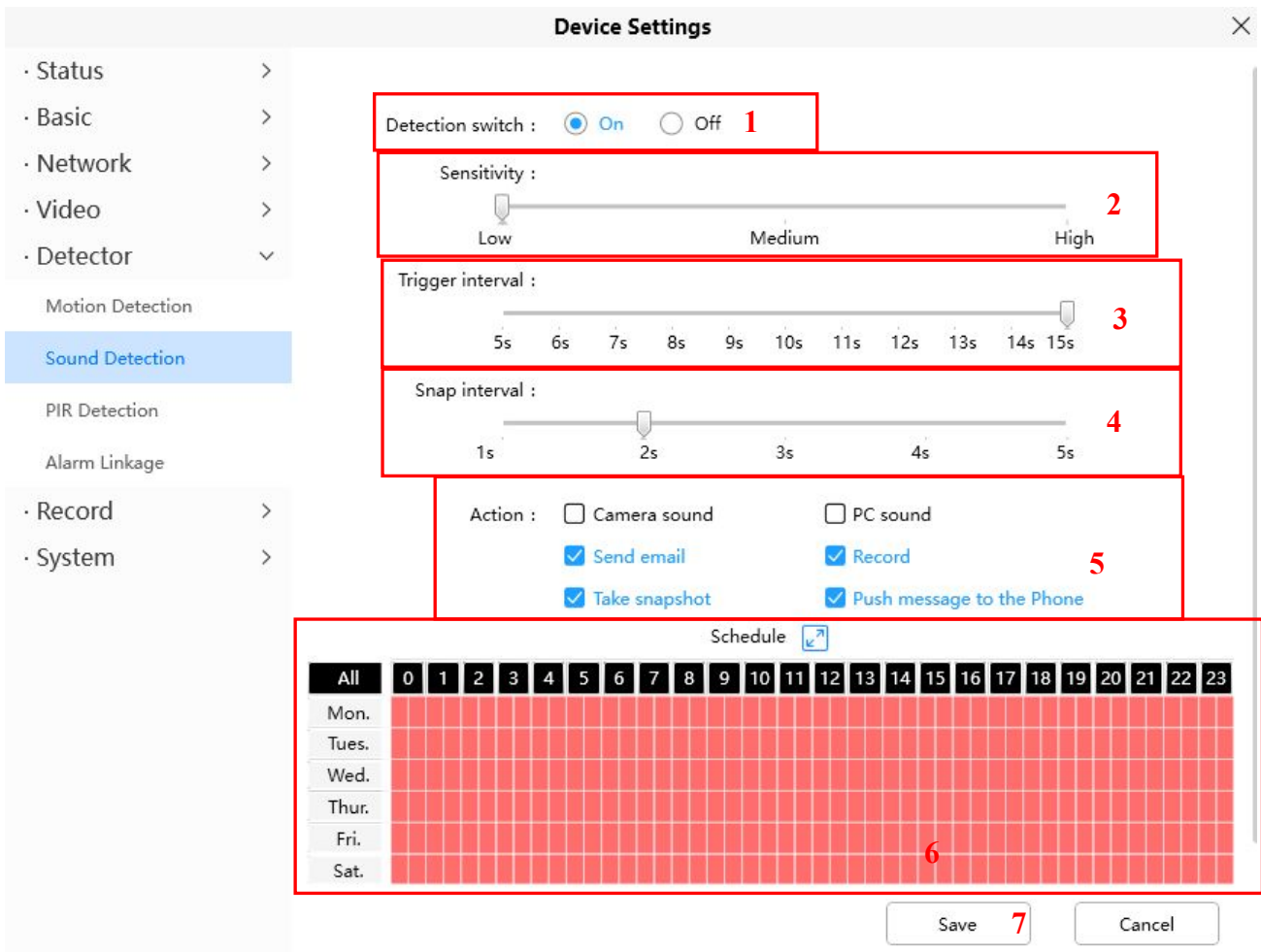

To enable motion detection, follow the steps below:

1 Enable Detection Switch

2 Sensitivity---- It supports three modes: Low, Middle and High. The higher the sensitivity, the camera will be more easily alarmed. Select one motion sensitivity.

3 Trigger Interval----The interval time between two motion detections. Here supports 5s/6s/7s/8s/9s/10s/11s/12s/13s/14s/15s. Select one interval time.

4 Snap Interval---- The interval time between two pictures.

5 Select the alarm indicators

There are some alarm indicators:

A Camera Sound

If you select Camera Sound, when the sound has been detected, the people around the Camera will hear beep alarm sound, if the device is connected with the audio output device.

B PC Sound

If you select PC Sound, when the sound has been detected, the people around the PC will hear beep alarm sound.

C Send E-mail

If you want to receive alarm emails when motion is detected, you must select Send E-mail and set Mail Settings first.

D Recording

If you select this checkbox, when the sound has been detected, the camera will recording and load it to the FTP server. Make sure you have set FTP and set FTP as the storage path in Video->Snapshot settings panel

E Take Snapshot

If you select this checkbox, when the sound has been detected, the camera will snap the live view window as a still picture and load it to the FTP. Make sure you have set the storage path in **Video > Snapshot Settings** panel.

F Push message to the phone

If you select this checkbox, when the sound has been detected, the camera will push the message to the phone which has been connected the camera.

6 Alarm Schedule

4. Alarm anytime when sound is detected

Click the black button up the MON, you will see all time range turn red. When something moving in the detection area at anytime, the camera will alarm.

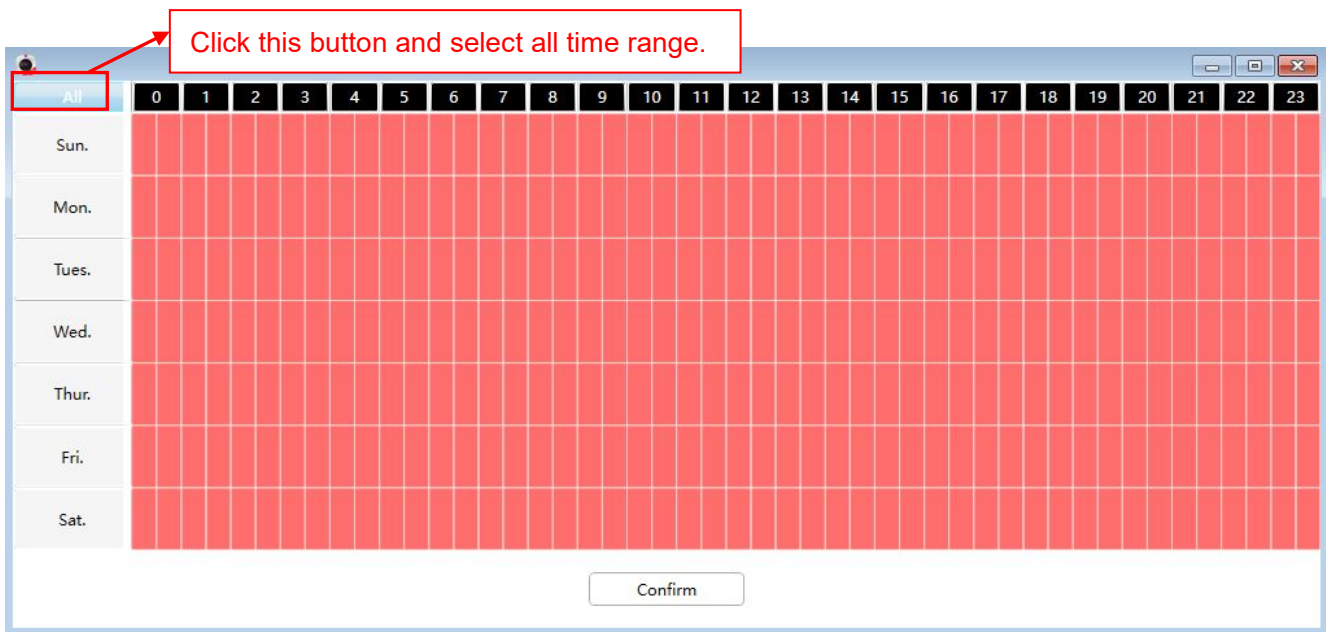

5. Specify an alarm schedule

Click the week day words, the corresponding column will be selected. For example, click TUE, the all column of TUE turns to red, that means during Tuesday whole day, when something sound in the detection area, the camera will alarm.



6. Press the left mouse and drag it on the time boxes, you can select the serial area,



7 Click Save button to take effect. When the sound is detected during the detection time in the detection area, the camera will alarm and adopt the corresponding alarm indicators.

NOTE: You must set the detection area and detection schedule, or else there is no alarm anywhere and anytime.

5.3.5.3 PIR Detection

Customize the area where you want motion to turn on your lights.



5.3.5.4 Alarm Linkage

After setting an URL, when camera triggers a detection, will call the URL.

step:

1. You can fill in the alarm linkage address in the Full URL and click the Generate button, or modify it in the saved information, then click Save.
2. Full URL example: <http://username:password@ip:port/json.htm?command=switchlight>.

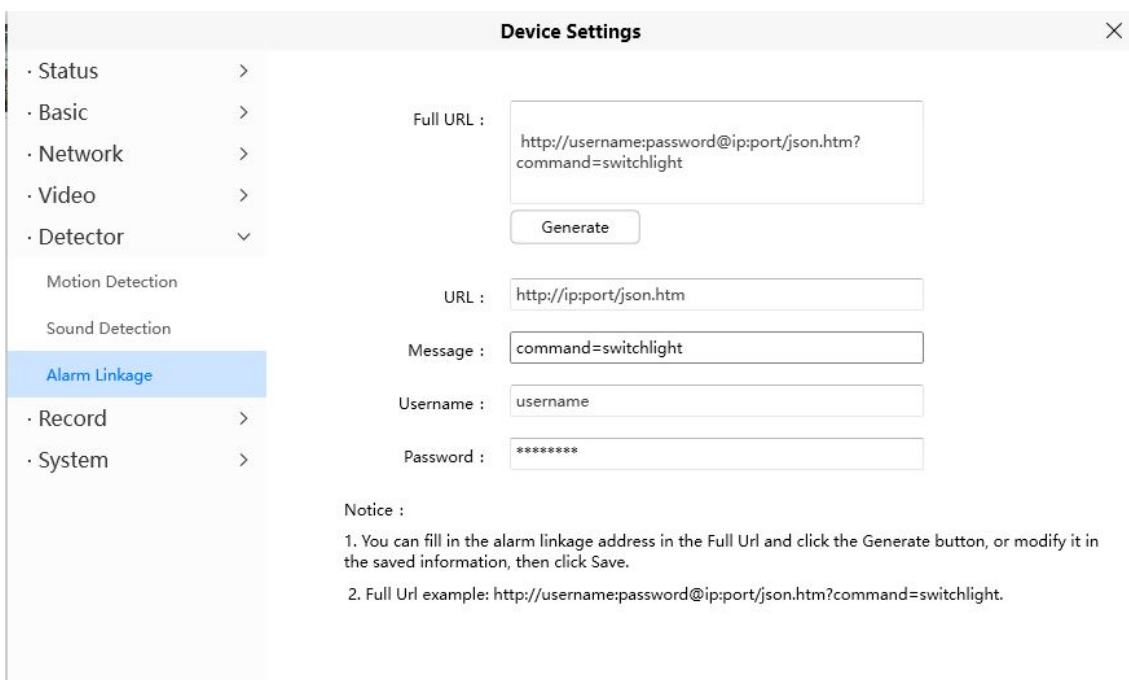

3.5.6 Record

3.5.6.1 Storage Management

On this page you can choose Record Storage Path. The record storage path default is SD card.

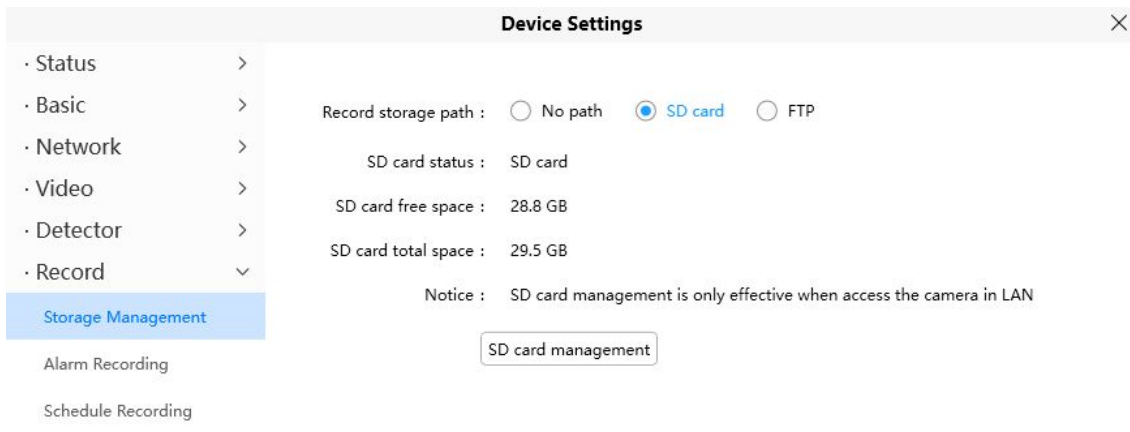

3.5.6.2 Alarm Recording

On this page you can configure the Alarm-recording Time, Enable pre-record time and Alarm-Recording time.

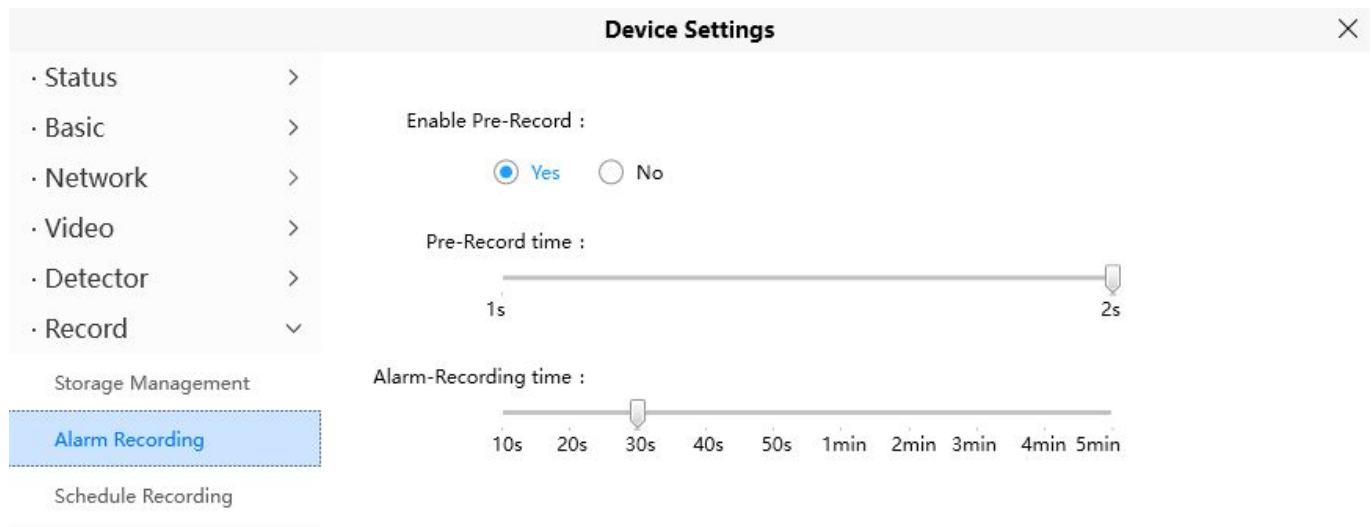

3.5.6.3 Schedule Recording

On the page you can configure the schedule record.

Note: Schedule Recording only supports SD Card. Schedule Recording can only be enabled after the recording path is set Please set the path in the storage management.

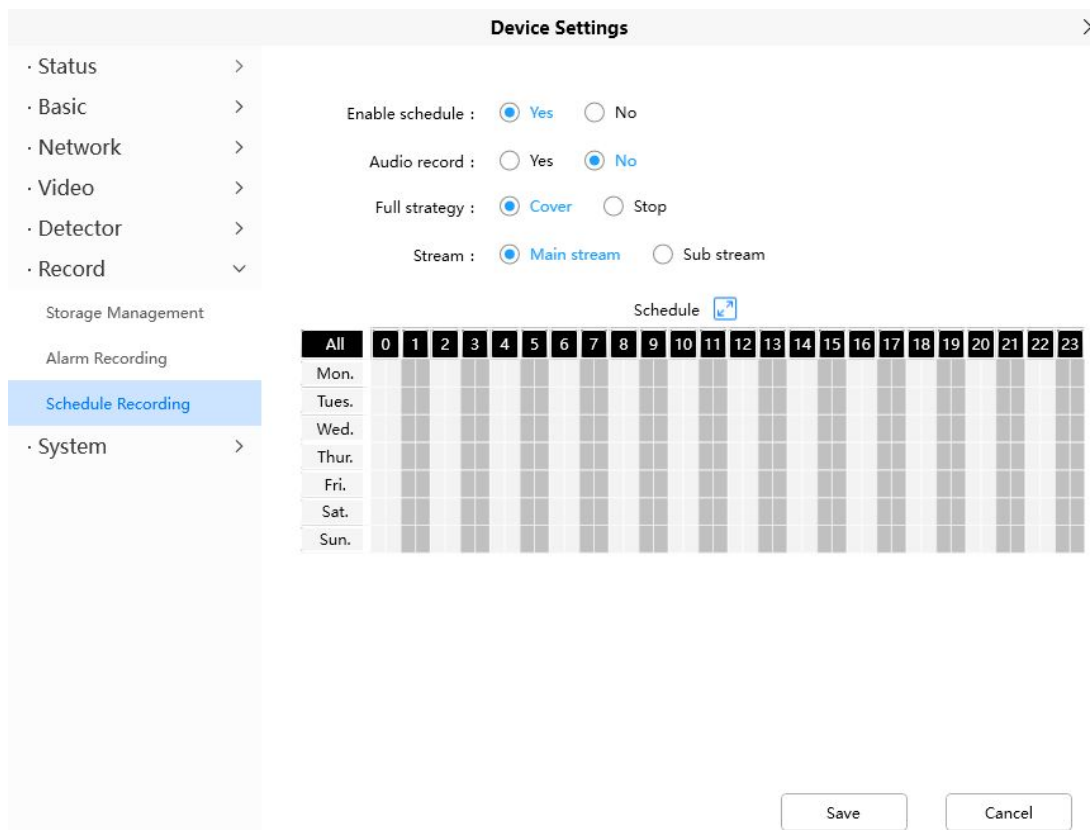

Click **Save** button to take effect.

3.5.7 System

In this panel, you can back up/restore your camera settings, upgrade the firmware to the latest version, restore the camera to default settings and reboot the device.

3.5.7.1 Back-up & Restore

Click Backup to save all the parameters you have set. These parameters will be stored in a bin file for future use.

Click Browse and select the parameters file you have stored, then click Submit to restore the restore the parameters.

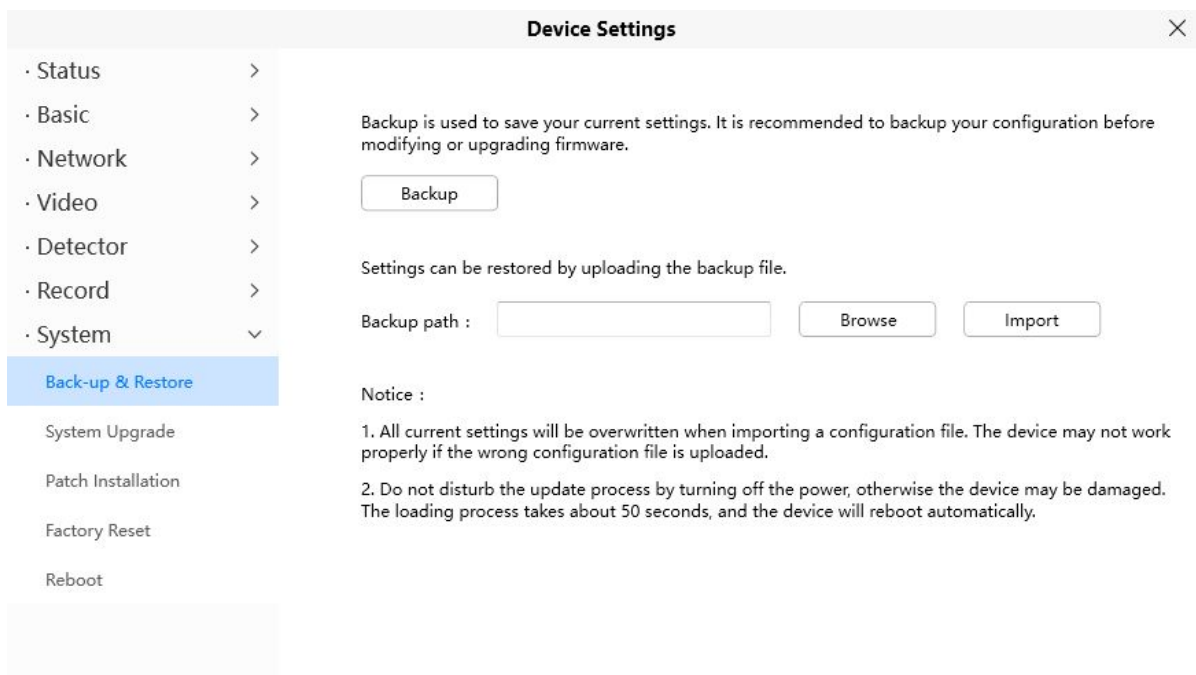

3.5.8.2 System Upgrade

Click **Download the Latest Firmware**, you will see the following screen. And click **Save** to save the firmware on your computer locally.

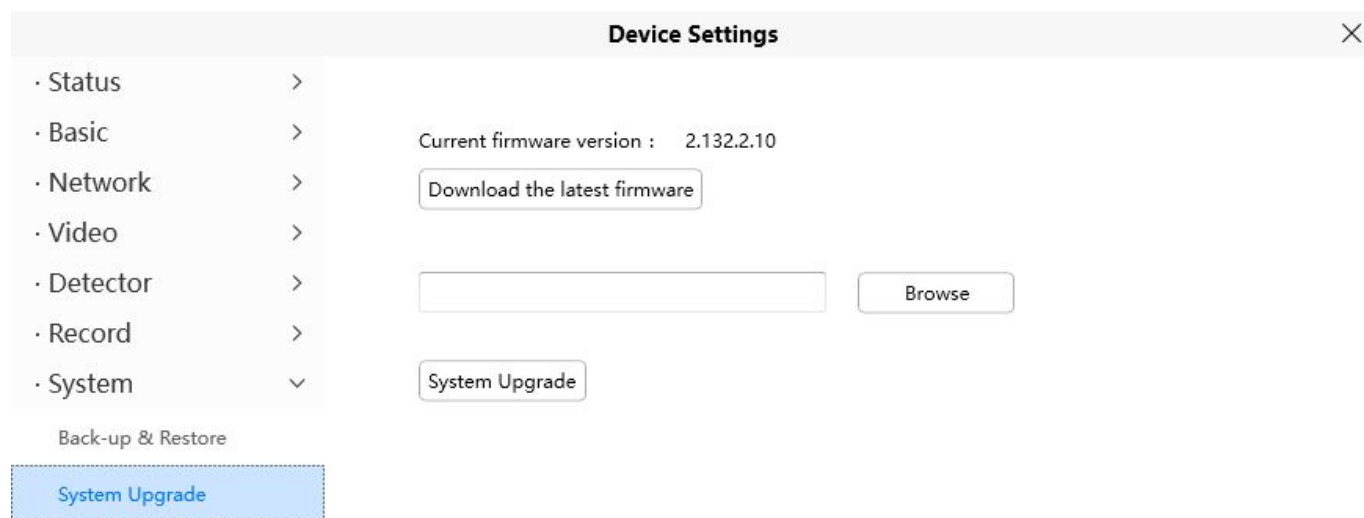

Your current firmware version will be displayed on your screen. You may go to the **Status > Device Information** page to check for the latest firmware versions available.

Click **Browse**, choose the correct bin file and then click **System upgrade**.

Don't shut down the power during upgrade. After upgrading, you can see the upgrade result.

3.5.7.3 Patch Installation

Click "**Browse**" to select the correct patch file, and then click "**Install Patch**" to install the patch. Do not turn off the power during it installing. After installing is complete, you will receive a system prompt.

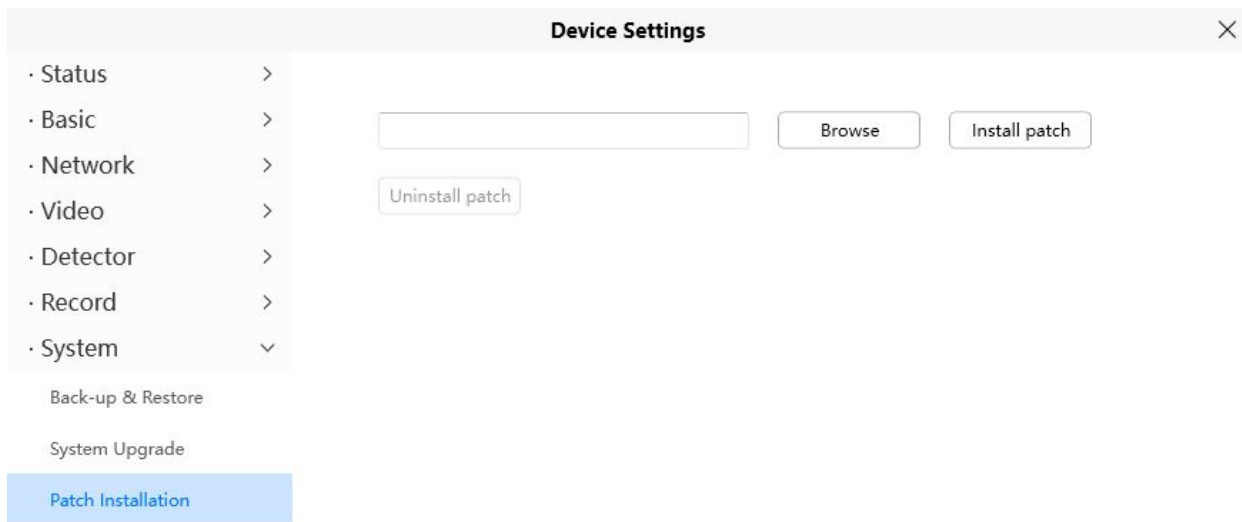

3.5.7.4 Factory Reset

Click **Factory Reset** button and all parameters will return to factory settings if selected.

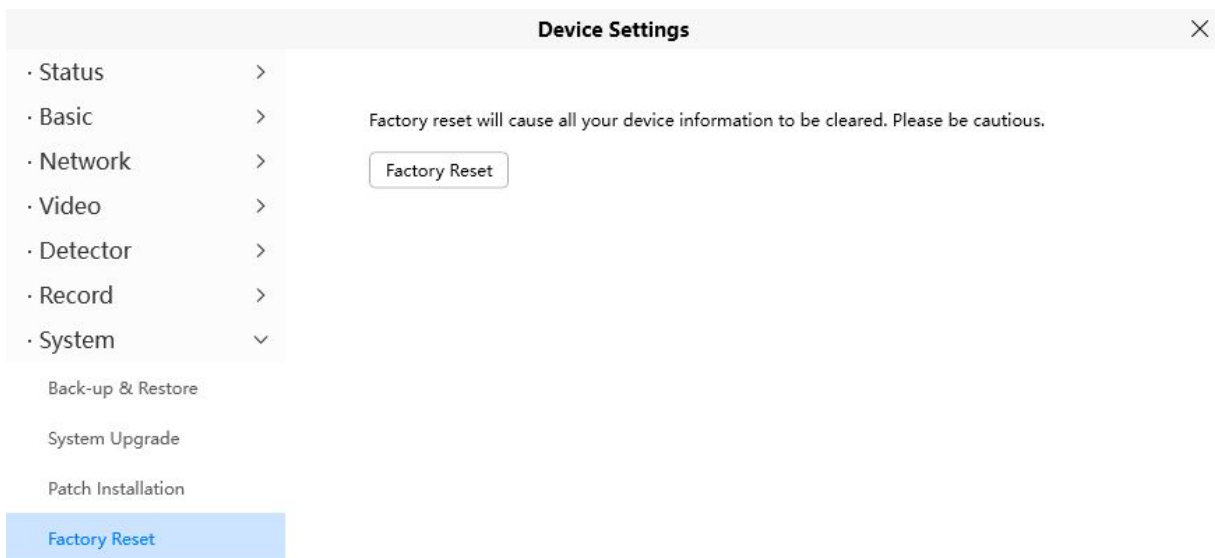

3.5.7.5 Reboot

Click **Reboot** to reboot the camera. This is similar to unplugging the power to the camera. You can set Enable periodic maintenance and set Period.

Device Settings



- Status >
- Basic >
- Network >
- Video >
- Detector >
- Record >
- System ▾

Back-up & Restore

System Upgrade

Patch Installation

Factory Reset

Reboot

Clicking this button will reboot the device

Reboot device

Enable Periodic Maintenance :

Yes No

Period :

A week A month

4 Appendix

4.1 Frequently Asked Questions

NOTE: Any questions you would meet, please check Network connections firstly. Check the working status revealed by the indicators on the network server, hub, and exchange. If abnormal, check the network connections.

4.1.1 Unable to connect to router wirelessly

After setup wireless configuration, and input the wireless password correctly, save the settings. Normally, after you disconnect the Ethernet cable, wait for few minutes camera will show up again in Foscam VMS LAN list with a new IP address. That indicates your camera's connected wireless.

If not, please follow below steps to help camera connect wireless.

Step1: Please make sure wireless signal is strong enough to connect with.

- (1) Best to keep the distance between the camera and router in 2~3 meters while setup;
- (2) There's no interference or obstacles from house appliance or walls;

Step2: Please check if your wireless password contains special characters.

Remove special character in SSID and wireless password to have a try.

Step 3: Reboot camera and router to have a check.

If above are all confirmed, power off and on the camera and router may help camera to connect.

Step 4: Please log-in the router and check if the MAC filter feature is enabled.

Camera has wired and wireless MAC, they are different. If your router has wireless MAC filtering turned on, it'll block camera to connect. Please turn it off, or add camera's MACs in the allow list.

Step 5: Please change the wireless channel, and the wireless encryption of router to have a try.

Change channel helps reduce influence from nearby WiFi networks, you can try 3,6,or 11 for example. As for encryption, suggest use WPA2/PSK AES.

Step6: At last reset camera to default, and please try re-configure the wireless settings again.

4.1.2 Forgot camera's user name and password

Camera can be hard reset to default settings, when you forgot camera's login user name and password. Below are the steps:

- (1) Keep power on camera;
- (2) Press and hold reset button of camera for 30 second, till it reboots. Reset button is on bottom, or back, or end cords of the camera.
- (3) Once reset, camera will be restored to default settings. Then re-use Foscam APP or FoscamVMS to add

and set a new user name and password.

4.1.3 How to setup alarm recording to Micro SD card

For the cameras that support Micro SD card, we can save alarm recording on SD card and below are the steps to set it up:

Step 1: Setup the Motion Detection Settings

Please go to **Device Settings > Detector > Motion Detection** menu.

- (1) Click **ON** for the Detection switch.
- (2) Choose **Recording** for the Action.
- (3) Set the Detection Area
- (4) Set a Schedule.
- (5) Click **Save** to save the settings.

The screenshot displays the 'Device Settings' window for 'Motion Detection'. On the left is a navigation menu with options: Status, Basic, Network, Video, Detector (expanded to show Motion Detection, Sound Detection, Alarm Linkage), Record, and System. The main area contains the following settings:

- Detection switch: On, Off, with a 'Set detection area' button.
- Sensitivity: A slider set to 'Low'.
- Trigger interval: A slider set to 10s.
- Snap interval: A slider set to 2s.
- Action: Camera sound, PC sound, Send email, Record, Take snapshot, Push message to the Phone.
- Schedule: A calendar grid with a red background, indicating the alarm is active for all days and hours.

At the bottom right are 'Save' and 'Cancel' buttons.

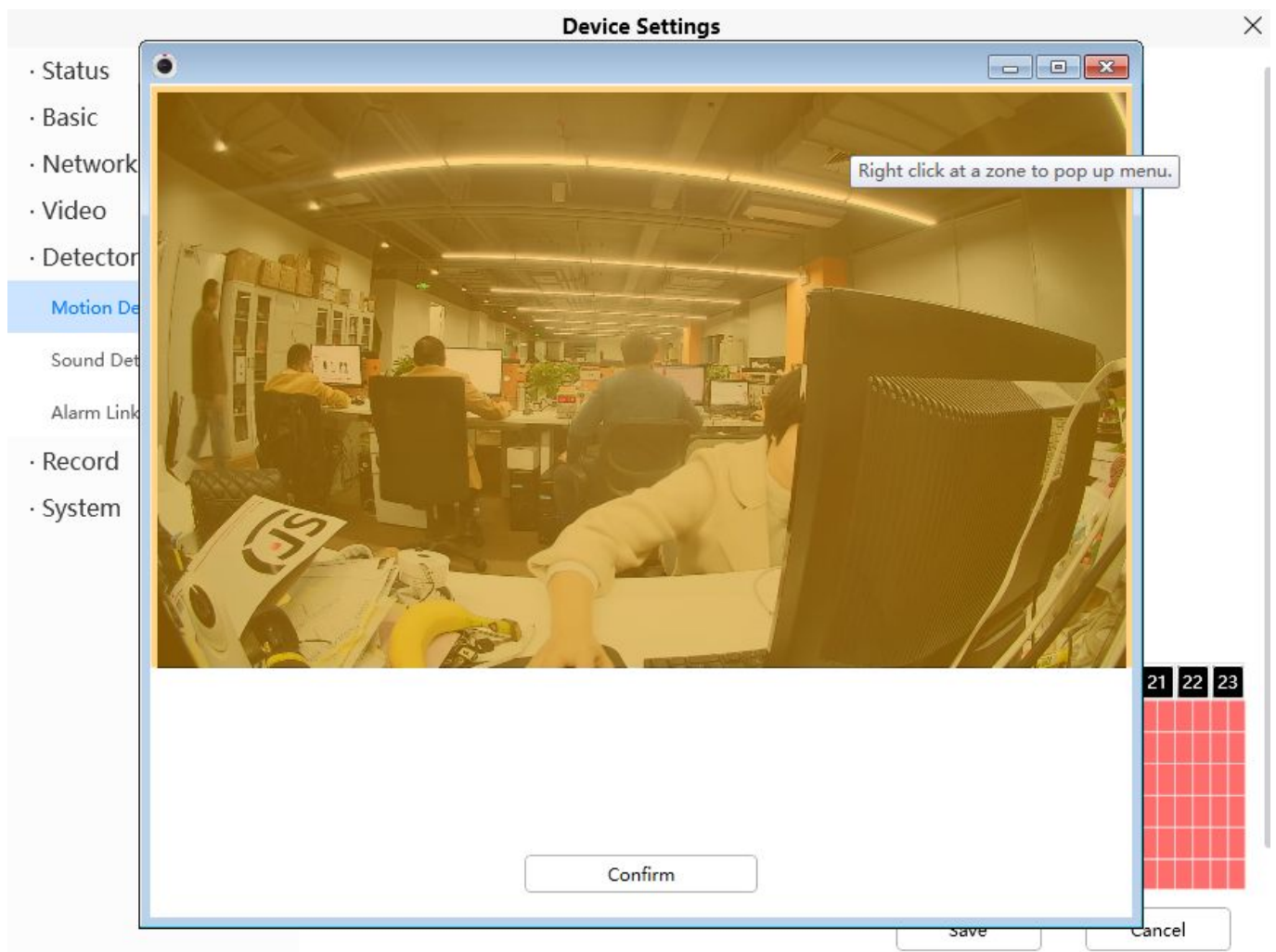

Note:

- 1) Please DO NOT forget to set the alarm schedule, the alarm schedule is red.
- 2) Please make sure your camera time is correct.
- 3) Please DO NOT forget to set the alarm area, the detected area is covered by the red grids. Or for some models you can setup 3 detection zones in total.

Step 2: Setup the Storage Location

Go to **Device Settings > Record > Storage Location**, and set the "Recording Location" to "SD card" and click **Save**.

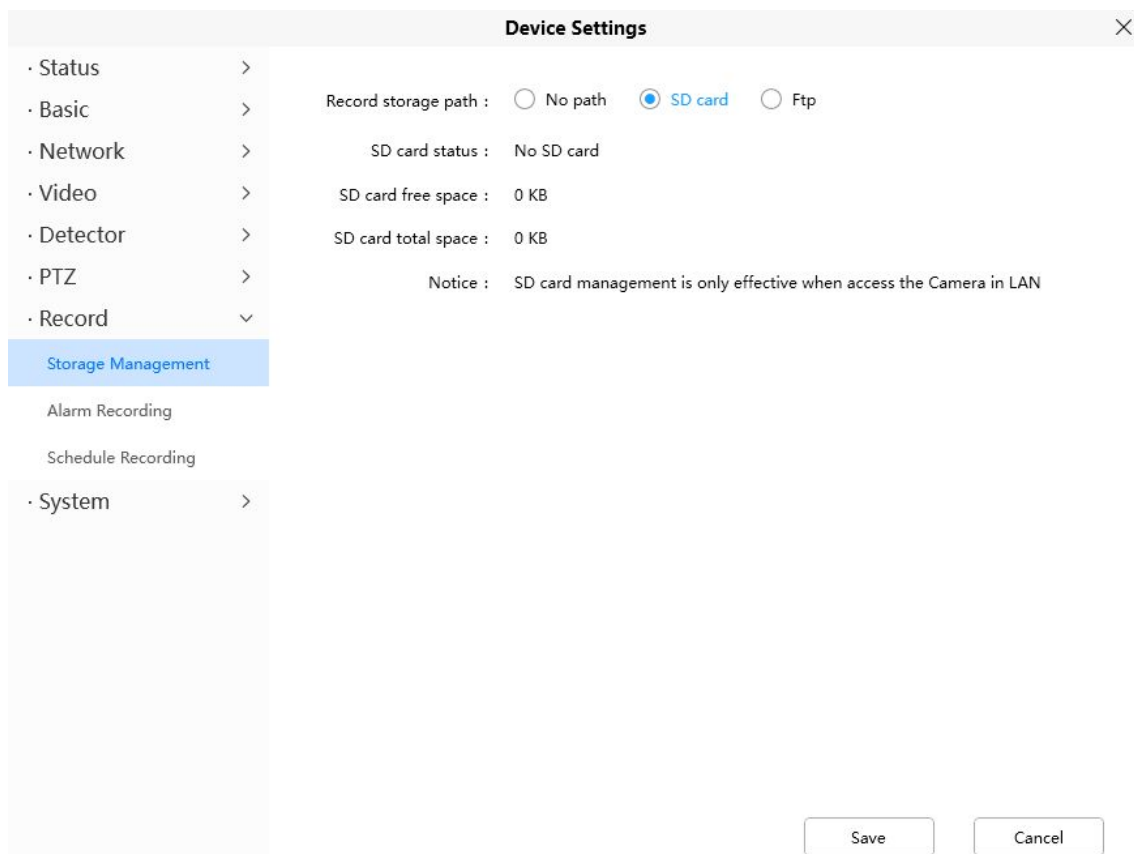

Note:

SD card needs format correctly so it'll be identified by camera, and has enough space for saving the recordings. It's suggested to use FAT32 for 4G~128G SD card.

4.1.4 Unable to connect camera remotely using Foscam app

Foscam P2P cameras allow users to connect camera remotely using Foscam app without extract setup like port forwarding. When it unable to connect remotely, below tips can help app establish the connection:

- (1) Update app and camera's firmware to latest version,
- (2) Power off the camera then power back on,
- (3) Delete camera from app then re-add it back, also lower camera's resolution.

4.1.5 Camera is added by others

When use Foscam app, one camera can only be added to one account at the same time. To solve error "This camera has already been added by another account" when add camera to Foscam app , please reset the camera.

More FAQs are available here:

<https://www.foscam.com/faqs/index.html>

4.2 Default Parameters

Default network parameters

IP address: obtain dynamically

Subnet mask: obtain dynamically

Gateway: obtain dynamically

4.3 Specification

ITEMS		Spot Camera
Spotlight	White LED	The irradiation distance of white light can reach 10m
	Color temperature	2800K
Image Sensor	Sensor	High Definition Color CMOS Sensor
	Display Resolution	2688*1520 (4.0M Pixels)
	Min. Illumination	0 Lux (With IR Illuminator)
Lens	Lens Type	Glass Lens
	focal length	2.8mm
	Aperture	F 2.4
	Angle of view	Diagonal:156°,Horizontal:121°,Vertical:61°
Video	Image Compression	H.264+
	Image Frame Rate	Max 25fps (4MP)
	Resolution	2K(2560x1440),1080P(1920x1080),720P(1280x720)
	Flip image	Flip and mirror
	Night mode	Manual and automatic modes,when the white light is on, the night vision image is colored
	Night visibility	10 m
Audio	Input/Output	Build-in mic and speaker,support full duplex real-time 2-way Audio
	Audio Compression	AAC
	Siren	Support maximum 110dB alarm siren
Network	Ethernet	One 10/100Mbps RJ45 port
	Wireless Standard	IEEE802.11b/g/n/ac
	Wireless Security	WPA, WPA2
	Remote Access	P2P
	Wifi configuration mode	Support scan QR code , sound wave to add camera
	Network Protocol	IP、TCP、UDP、SMTP、FTP、DHCP、RTSP、ONVIF
Software Features	Light control	Manual switch or alarm linkage, support the adjustment of light brightness

	Motion Detection	Alarm via E-Mail, upload alarm snapshot to FTP , push message to mobile phone and push stream to Cloud
	Sound Detection	Alarm via E-Mail, upload alarm snapshot to FTP , push message to mobile phone and push stream to Cloud
	Human Detection	Alarm via E-Mail, upload alarm snapshot to FTP , push message to mobile phone and push stream to Cloud
	PIR Detection	Built in 1pcs PIR Sensor,Supports sensitivity and range adjustment
	Privacy Block	Yes
	User Accounts	Three levels user role
	Firewall	Supports IP Filtering
	Custom ringtones	Support to switch on/off white light through mobile APP
	Micro SD card	Support maximum 128GB Micro SD card storage
	Cloud	Support cloud storage
LED	Indicator LED	Blue&Red
Reset	Reset	Reset button is available
Power	Power Supply	DC12V/1A
	Power Consumption	12Watts (Max.)
Physical	Dimension(LxWxH)	170 (L)x75 (φ) mm
	Net Weight	290g
Accessories	Installation Kit	Matching waterproof junction box is available(Needs to be buy separately)
Environment	Waterproof	IP66
	Operating Temperature	-20°C~ 60°C (-4°F ~ 140°F)
	Operating Humidity	20% ~ 85% non-condensing
	Storage Temperature	-20°C ~ 60°C (-4°F ~ 140°F)
	Storage Humidity	0% ~ 90% non-condensing
Certification	CE, FCC、RoHS,WEEE	

4.4 CE & FCC

Electromagnetic Compatibility (EMC)

FCC Statement



FCC Warning

This device complies with Part 15 of the FCC Rules. Operation is subject to the following two conditions: (1)

This device may not cause harmful interference, and (2) this device must accept any interference received, including interference that may cause undesired operation. NOTE 1: This equipment has been tested and found to comply with the limits for a Class B digital device, pursuant to part 15 of the FCC Rules. These limits are designed to provide reasonable protection against harmful interference in a residential installation. This equipment generates, uses and can radiate radio frequency energy and, if not installed and used in accordance with the instructions, may cause harmful interference to radio communications. However, there is no guarantee that interference will not occur in a particular installation. If this equipment does cause harmful interference to radio or television reception, which can be determined by turning the equipment off and on, the user is encouraged to try to correct the interference by one or more of the following measures: - Reorient or relocate the receiving antenna. - Increase the separation between the equipment and receiver. -Connect the equipment into an outlet on a circuit different from that to which the receiver is connected. -Consult the dealer or an experienced radio/TV technician for help.

This equipment complies with FCC radiation exposure limits set forth for an uncontrolled environment .This equipment should be installed and operated with minimum distance 20cm between the radiator& your body.

NOTE 2: Any changes or modifications to this unit not expressly approved by the party responsible for compliance could void the user's authority to operate the equipment.

CE Mark Warning



This is a Class A product. In a domestic environment, this product may cause radio interference, in which case the user may be required to take adequate measures.

4.5 WARRANTY

FOSCAM values your business and always attempts to provide you the very best of service.

No limited hardware warranty is provided by FOSCAM unless your FOSCAM product ("product") was purchased from an authorized distributor or authorized reseller. Distributors may sell products to resellers who then sell products to end users. No warranty service is provided unless the product is returned to an authorized return center in the region where the product was first shipped by FOSCAM or to the point-of-purchase, which may have regional specific warranty implications.

If you purchase your FOSCAM product from online store, please contact the point-of-purchase and ask for return / replacement / repair service.

Limited Hardware Warranty

FOSCAM products are warranted to be free from manufacturing defects in materials and workmanship starting from the shipping date of FOSCAM.

This limited hardware warranty does not cover:

- Software, including the software added to the products through our factory-integration system, software,etc.
- Usage that is not in accordance with product instructions.

- Failure to follow the product instructions.
- Normal wear and tear.

Return Procedures

- Please read FOSCAM warranty policy & policy of your reseller first before sending items back to point-of-purchase.
- Customer must first contact point-of-purchase to obtain a Return Merchandise Authorization (RMA) number before returning the product. If the product you received is suspected to be defective and the product warranty has not expired, The RMA number will allow your reseller to track your return much easier and help them expedite processing your request.
- After receiving your RMA case number, pack the item(s) very well with the original box and all the original accessories included such as power adapters, brackets, cables, manuals.
- Write your RMA number and the return reason (the problem of the product) on the warranty card along with the complete package to send them back.

Replacement Services

- **If customers ask for replacement service, please contact point-of-purchase and follow their policy.**
- Our technicians will inspect all items returned for replacement requests. If the returned product is found in working order, we will return the same item received. However customers shall be responsible for all shipping & handling charges incurred for getting the units back to customers.
- If returned products are found defective, we will replace the product and assume the shipping cost for sending back the replacement unit to customers.
- If for any reason, we are unable to provide a replacement of the original returned item(s). You will have a choice for a "Substitute" item at the same equal value.
- We do not provide exchange and replacement due to normal hardware upgrade according the market after 14 days after the product is delivered.
- Our technicians will test the product before send out the replacement, any other demand for more than two times replacement for the same product during replacement limit will be rejected.
- **Replaced products are warranted from the balance of the former warranty period.**

Warranty Forfeiture

- Warranty is void if purchase from unauthorized distributor or reseller.
- **Warranty is void if trade-mark, serial tags, product stickers have been removed, altered or tampered with.**
- Warranty is void for mishandling, improper use, or defacing the product.
- Warranty is void for physical damage, altered, either internally or externally, improper or inadequate packaging when returned for RMA purposes.
- Warranty is void if damage has resulted from accident, dismantle, abuse, or service or modification by someone other than the appointed vendor, source, fission or the spare part has been over the period of warranty.
- Warranty is void if product is damaged due to improper working environment or operation. (For example, improper temperature, humidity, unusual physical or electrical stress or interference, failure or fluctuation of electrical power, static electricity, using wrong power adapter, etc.)
- Warranty is void if damaged by the use of parts not manufactured or sold by FOSCAM.
- Damage caused by improper installation of third-party products.
- Warranty is void if damaged for irresistible cause, such as earthquake, fire, lightning, flood, etc.

- Product beyond limited warranty.

Shipping Fee

- If products are defective or damaged under normal use or operation in the replacement limit, distributors or resellers are responsible for the shipping cost the product back to customers, customers should assume the shipping cost send the product to the point-of-purchase.
- During replacement limit, if customers ask for replacement due to the product does not fit for customer's personal expectation, customers should responsible for both shipping fee.
- Customers shall be responsible for both shipping fee if their product beyond the replacement limit but still in warranty limit.

Repair Service Out Of Warranty

- FOSCAM provide extra repair service for product that out of warranty, it is chargeable. The total fee contains device cost and service fee. Device cost (including accessories) is the standard uniform price provide by FOSCAM.
- Different region may have different service fee, please contact the point-of-purchase to confirm that before you ask for this service.
- Our technicians will quote the total price after detect the product, If customers refused to repair after the quotation, customers need pay for the test fee, \$3.5 / hour. If agree with the quotation, test will be free.
- Repaired product out of warranty will obtains 3-month warranty from the date of the product back to customers.

Limitation of Liability

- FOSCAM is not responsible for other extra warranty or commitment promised by resellers, if your reseller promised some extra commitment or warranty; please ask for written documents to protect your rights and interests.
- FOSCAM does not offer refunds under any circumstances. Please contact the point-of-purchase and follow their refund / return policy.
- FOSCAM shall not be liable under any circumstances for any consequential, incidental, special or exemplary damages arising out of or in any connection with this agreement or the products, including but not limited to lost profits, or any claim based on indemnity or contribution, or the failure of any limited or exclusive remedy to achieve its essential purpose or otherwise. Purchaser's exclusive remedy, as against FOSCAM, shall be the repair or replacement of defective parts. If FOSCAM lists a product on its website specification in error or that is no longer available for any reason, FOSCAM reserves the right to explain it without incurring any liability.

All rights reserved. FOSCAM and the FOSCAM logo are trademarks of ShenZhen FOSCAM Intelligent Technology Limited., registered in the U.S. and other countries.

4.6 Statement

You are advised to be cautious in daily life, keep personal account information carefully, do not share personal account easily. Change passwords of your account and equipment periodically, and upgrade equipment firmware to strengthen security consciousness.

Our company makes no warranty, implied or otherwise, that this product is suitable for any particular purpose

or use. You need to abide by the relevant laws and regulations of the use restrictions when using Foscam cameras. Our company takes no responsibility of illegal activities by using our products.

Our company takes no responsibility of the loss by force majeure, such as failure or faults of telecom system or the Internet network, computer viruses, malicious attacks of hackers, information damage or loss, and faults of computer system.

Foscam company does not need to take any responsibility of the special, incidental or corresponding loss by the products of our company or any software provide by our company, including but not limited to operating loss, profit or purpose. The company only takes the responsibility applicable to national and local legal requirements.

Our company takes no responsibility of the loss caused by the following at any time:

- 1) loss of purchases;
- 2) loss of intangible property damage, such as data, programs;
- 3) loss of compensation claimed by third-party customers.

Delete images, format the memory card or other data storage devices does not completely remove the original image data. You can restore deleted files from discarded the storage device by commercial software, but which will potentially lead to personal image data used maliciously by others. The privacy of the data security belongs to user responsibility, the company takes no responsibility.

Parts mentioned in this statement should not be understood by the configuration description of the product purchased by the customer, the product configuration must accord to the specific models purchased by the customer.

Without the prior written permission of Foscam company, all the contents of relevant operating instructions manual affiliated to the product must not be reproduced, transmitted, transcribed or stored in a retrieval system, or translated into other languages.

Our company will reserve the right to improve and modify the product and corresponding manuals. The company reserves the right of final interpretation on our products.

5 Obtaining Technical Support

While we hope your experience with the IP camera network camera is enjoyable and easy to use, you may experience some issues or have questions that this User's Guide has not answered.

If you have problem with FOSCAM IP camera, please first contact FOSCAM reseller for solving the problems.

If our reseller cannot provide service, please contact our service department:

support@foscam.com



CE Certificate statement Website: <https://www.foscam.com/company/ce-certificate.html>

Exporter and Importer Information Opened to Public: <https://www.foscam.com/company/open-information.html>

Manufacturer: Shenzhen Foscam Intelligent Technology Co., Ltd

Addr: Room 901-902, Building 1B, Xingke 1st Street, Shenzhen International Innovation Valley, Nanshan Dist., Shenzhen, 518055, China